

ThruScan Metal Detectors

WTMD/User Manual

Version: 15.10

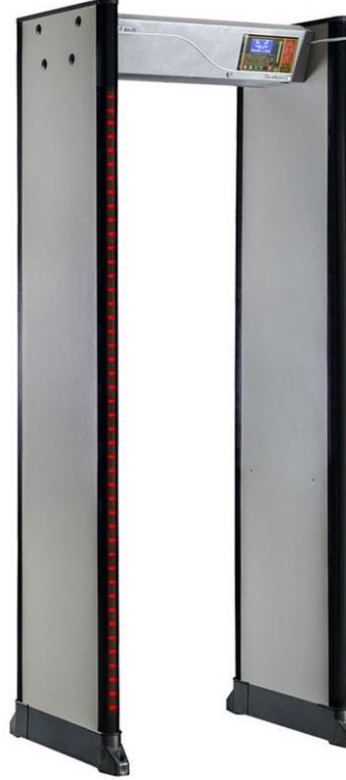

 **ELEKTRAL**[®]
ELEKTROMEKANİK San. ve Tic. A.Ş.



MAIN CONTACT-FACTORY:

Ataturk Industrial Zone

M.K. Ataturk Blv. 23 Cigli

35620 Izmir -TURKEY

Phones : +90(0)232 376 7300

Fax : +90(0)232 376 7030

e-mail : elektral@elektral.com.tr

www.elektral.com.tr

<u>Contents</u>	<u>Page</u>
PREFACE	4
Contents.....	5
Before Use	6
1. GENERAL DESCRIPTION.....	8
1.1 <i>ThruScan</i> s3 Walk Through Metal Detector	9
1.3 <i>ThruScan</i> s6 Walk Through Metal Detector	10
1.3 <i>ThruScan</i> s9 Walk Through Metal Detector	11
1.4 <i>ThruScan</i> sX Walk Through Metal Detector	12
1.5 <i>ThruScan</i> sX-WP Walk Through Metal Detector	13
1.6 <i>ThruScan</i> s15-i Walk Through Metal Detector	14
1.7 <i>ThruScan</i> sX-i Walk Through Metal Detector.....	15
2. INSTALLATION	16
2.1 Site Selection	16
2.2 Assembling & Mounting.....	16
2.2.1 Assembling.....	16
2.2.2 Assembling.....	17
2.2.3-4. Assembling	17
2.2.- 5.6.7.8.9.10.11.12.13.14 Assembling	17
3. CONTROL DISPLAY PANEL & INDICATION INFORMATION	18
3.1 Control Panel.....	18
3.1.1 LCD Display.....	18
3.1.2 Grafic (Alarm) Zone LEDs (Locater)	18
3.1.3 VU Display (LED Array).....	19
3.1.4 UPS Indicator	19
3.1.5 IRDA Remote Control Receiver	19
3.1.6 Traffic Indicator LEDs (Lights).....	19
3.2 Touch Pads.....	19
3.2.1 ON- OFF Button	19
3.2.2 RUN(X) Button	19
3.2.3 SEL(√) Button.....	20
3.2.4 Up-Down Buttons	20
3.3 Traffic Lights.....	20
3.4 Zone (Indicator) Light's.....	20
3.5 Various Alarms	20
3.6 Relay-Contact Outputs	21
3.7 Synchronization and Remote Control Outputs	21
4. PROGRAMMING & SET UP	22
4.1 Programming MENU	22
4.1.1 Security Level & Sensitivity Level Adjustments	23
4.1.2 Security Level & Sensitivity Level, Zone Adjustment (sX Series)	25
4.1.3 Auto Detection & Auto Sensitivity Assignment (sX)	25
4.1.4 Alarm Volume & Tone Adjustment.....	26
4.1.5 Alarm Counter	26

4.1.5.1 ThruScan s3/s6/s9/sX/sX-WP	26
4.1.5.2 Alarm Counter for ThruScan sX-i	27
4.1.6 In-Coming / Out-Going Counter (Traffic Counts)	27
4.1.6.1 For ThruScan s3/s6	27
4.1.6.2 For ThruScan s9/sX/sX-i/sX-WP	28
4.1.7 Factory Settings	28
4.1.8 Language Selection	29
4.1.9 Counter Visibility	29
4.1.10 New Password	30
4.1.11 Environment Noise Level	30
4.1.12 Pass Sensor	31
4.1.13 Alarm Tone Duration Select	31
4.1.14 Operation Duration.....	31
4.1.15 Random Alarm Rate Selection	32
4.1.16 Alarm Rate and Operation Duration	32
4.1.17 Selecting Operating Channels.....	32
4.1.18 Date and Time Settings.....	33
4.1.19 Major Error.....	33
4.1.20 SCADA Address.....	34
4.1.21 Panel Visibility.....	34
4.1.22 SCD Statistics.....	34
4.1.23 Statistics Menu.....	35
5. SYSTEM OPERATION	35
5.1 Normal Operating Mode	35
5.2 Routine Tests	35
5.3 Alarm State.....	36
6. TECHNICAL SPECIFICATIONS	36
6.1 Electronics.....	36
6.2 Detection Field	37
6.3 Language.....	37
6.4 Self Test.....	37
6.5-6.6 Sensitivity-Memory	38
6.7-6.9 Traffic Counter- Regulatory Information	38
6.10 Infrared Sensor	38
6.11-6.12 Electromagnetic Noise & Interference Rejection-Masking	39
6.13 Synchronisation	39
6.14 – 6.15 Electrical Requirements & Consumption Efficiency.....	40
6.17 Humidity	40
6.18 Throughput/Traffic Rate.....	40
6.19 Weight	40
6.20 Warranty Period	40
6.21 Dimensions	40
7. OPTIONS	41
7.1 SRC-SCADA Remote Control Package	41
7.1.1 SRC-SCADA Remote Control Software.....	41
7.1.2 Remote Control (by Modem)	42
7.1.3 Remote Control (by Cable)	42

7.2 Outdoor Package	43
7.2.1 Rain Protect Shelter/Hat.....	43
7.2.2 Side Panel Protection Cover	43
7.3 Battery Group	43
7.4 WTMD Wheeler	43
7.5 Carriage Bag.....	43
7.6 IRDA Remote Control	44
7.7 Real-Time Visual Prosecution Unit	44
7.8 Alarm Output	46
7.9 NILECJ Test Kit	48
7.10 LED Zone Indicators on Both Sides.....	48
7.11 Object Sliding Table	48
7.12 Queue Barrier.....	48
7.13 Hand-Held Metal Detector	48
7.14 ShoeScan Metal Detector	48
8. MAINTENANCE & REPAIR.....	49
8.1 Periodic Maintenance.....	49
8.2 Repair	49
8.3 Module Replacement	49
8.4 Warranty Provisions	49
9. TROUBLESHOOTING.....	50
9.1 Frequently Asked Questions.....	50
9.2 Installation Problems.....	51
9.3 Operational Problems	53
10. APPENDIX	55
10.1 Certificate of Expertise	55
10.2 SRC SCADA Remote Control	55
10.2.1 ThruScan s3/s6/s9 SRC SCADA Program Manual	55
10.2.2 ThruScan sX/sX-i/sX-WP SRC SCADA Program Manual.....	56
10.3 IRDA Remote Control Unit Manuel	57
10.4 Users Manuel For Wheeled Transportation Accessory	58
10.5 Certificate of Warranty	60

© 2005 ELEKTRAL® A.S. – **ThruScan** Metal Detectors
All rights reserved. Protected by Law Number 4110 and Ideas and Works of Art Law 5846, unless a written consent by its copyright owner, ELEKTRAL® A.S. according to the 52. Article is provided, this manual, under no circumstances may be processed, copied, its duplicated copies published, represented, presented, in any form or by any means by mechanical and/or electronic ways be transmitted or used.

PREFACE

Dear User;

You have taken some serious measures on entrance-control security in environments where it's required, with the Magnetic Walk Through Metal Detector - (WTMD) you have purchased. Thank you for choosing an ELEKTRAL product with ELEKTRAL's warranty.

With ELEKTRAL *ThruScan* (s3/s6/s9/sX/s15-i/sX-i/sX-WP) Multizone Walk Through Metal Detectors your security searches will be more effective and your estates will be more secure, providing you peace of mind.

ThruScan metal detectors are in conformance with international norms and regulations written in this field and approved by British and German companies as well as other international market companies, with credible references.

ThruScan will earn your approval with quality, service guarantee and economic prices.

Thank you for selecting a product manufactured by ELEKTRAL A.S.
We hope to earn your admiration through many other professional ELEKTRAL products.

Please make sure you read this user manual carefully before switching on this versatile electronic equipment.



ELEKTRAL Products are:

Produced in environmentally friendly modern facilities

Causing no harm to nature and living creatures.

- MADE IN TURKEY
- ALTERATIONS RESERVED.
- NO CLAIMS CAN BE ACCEPTED BY OUR FIRM REGARDING THE APPLICATIONS OF THIS INSTRUMENT FROM SECOND OR THIRD PARTIES.
- ALL RIGHTS RESERVED.
- PLEASE FIND OUR "Conditions of Sales, Delivery & Warranty" on our website.

CONTENTS



Procedures and Safety Warnings before using *ThruScan*



Technical specifications of *ThruScan*



Preparation and mounting



ThruScan usage programming and relevant procedures



The arrow-end lightning symbol inside the equilateral triangle informs the user that in the context of the product, there is enough amount of 'uninsulated' dangerous voltage to cause an electric shock.

**DO NOT OPEN *ThruScan*[®]
ELECTRONIC CASE
RISK OF ELECTRIC SHOCK**



The exclamation mark inside the equilateral triangle informs the user that there are important instructions of useage and information inside the booklets given with the equipment.

Necessary Procedures and Safety Warnings Prior to Using *ThruScan*



Prevent direct light exposure to the infrared sensors (see Sec. 6.10) of your *ThruScan* WTMD.



Leave minimum 1m of distance between your *ThruScan* and any objects such as metal doors, X-Rays, turnstiles, as such.



Do not place any covers, plating or loads that would induce weight over your *ThruScan* unless being recommended by the factory.



Do not drill any holes on the panels of your *ThruScan* under any circumstances.

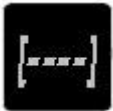

Your *ThruScan* is secured both by a mechanical lock and an electronic PIN CODE as a precaution against unauthorized people. Do not share your password. Contact the factory if you forget the password.



Assemble your *ThruScan* on a horizontal and flat floor. Make sure it is fixed firmly to the floor.



Do not assemble your *ThruScan* on an unstable or moving floor surface.



Do not let unauthorized persons to intervene *ThruScan*'s electronic units. Contact your dealer or the factory for an authorized service person.



Use soft, damp clothing to clean your *ThruScan*. Always unplug your equipment during cleaning.



Never operate your equipment through mains without norm ground



ThruScan is designed to operate between 70~270 VAC / 50Hz~60 Hz.

CAUTION! Misuse of this equipment specified by the manufacturer may damage the metal detector or injure people.



Technical Specifications:

Electrical : 70 – 270 VAC (Electricity power supply should be earthed & stable)
10 Watts standby, 20 Watts max in alarm. A-Class Energy Save
Frequency: 50/60 Hz



Maximum Relative Humidity : 95% non-condensing
Operating Temperature : -20° ~ +70° C

WARNING:

If the ThruScan Metal Detector will be controlled from a distance via SRC-SCADA Remote Control software on a PC, both the PC and the metal detector must be earthed at the same power line. Otherwise issues causing breakdowns may occur.

Standards:

The units comply with NILECJ L/1-3 standards

ThruScan is within the magnetic emission limits approved by FDA (American Food & Drug Administration). It has been certified by experts that has no effects on living creatures, cardiac pacemakers, pregnant women as well as magnetic media. A "report of expertise" on this issue is presented in Appendix-1. See Section 10.1.

Protect your *ThruScan* from direct rain, mist and/or condensation and place it on a stable, vibration free floor.

DO NOT place the *ThruScan* close to telephone lines, television monitors, electric motors, transformers, power cables, or control circuits; excessive electrical noise may cause false measurements.

CAUTION! ThruScan has to be firmly fixed to the floor to reduce the risk of accidentally falling over and injuring people or causing damage.

Do not drill holes into the side panels under any circumstances!

The walk through metal detector is ready to use once the green "ready LED" (Light Emitting Diode) light is on.

Test your apparatus periodically, especially when physical environmental displacements have occurred around it.

NOTE: Security metal detectors have been designed to be used within a comprehensive security-screening plan. It is the user's responsibility to define the area coverage the overall plan and ensure that it operates effectively.

1. GENERAL DESCRIPTION

ThruScan WTMD's are all easy to operate, advanced microprocessor controlled, with digital pulse induction utilizing VLF Technology that provides superior metal discrimination and detection. *ThruScan* sX/sXWP/s15-i/sX-i are versatile and easily portable walk-through metal detection units providing high level of detection with a walk-thru rate of up to 60 persons per minute. (* for *ThruScan* s3/s6 approx. 30 persons/min)

ThruScan s15-i/sX-i have fifteen / nine stable and homogeneous detection fields that comprise of several horizontal and vertical zones, which can detect metal objects within separate scanning zones of the WTMD. With widened, stable and homogeneous detection zones, the WTMD determines the search locations for the target objects and displays them on the side panels with LED lights and on the LCD display graphically, thus speeds up the walk through process substantially. The operator needs to search only the indicated areas by *ThruScan*'s s9/sX/sX-i/sX-WP on the side panels. See Section 3.4

A bright, highly visible LED VU display provides a visual indication of the level of detection of metals within the field of detection. Operator may also approximate the magnitude of the metal by the warning sound without looking the *ThruScan*'s VU-meter on the Control Panel.

Traffic LED's (Green or Red) on the side panels (ENTER SIDE) show if WTMD is ready to pass through. If the lights show green the gateway may be entered, if the lights show red the person must not enter. See Section 3.3 (****for ThruScan s3/s6 traffic lights are under the Control Panel at gateway***)

Zone lights show the location of the metal object whether it is on the left, right, top, bottom or at the centre of the body and are located on the side panels of the exit side of the gateway. Zone lights originate from LED arrays of 2x6 to show 9 zones. These zones are being indicated on the control panel also by "Graphic Zone LEDs (Locator)". (****for s3/s6 models, display is only at the control panel***)

A backlit LCD Display (monitor), (See Program MENU Section 3.1.1) is located on the overhead Control Unit and displays operational information including program, alarm and sensitivity settings as well as a traffic count of both in-coming and out-going passes.

A see through cover with mechanical lock (**** optional for ThruScan s3/s6***) enables access to the Control Unit in order to prevent unauthorized tampering. Calibration and control settings are further protected by a Programmable 4 digit PIN CODE. See Section 6.8

ThruScan (s9/sX/s15-i/sX-i/sX-WP) also incorporates an integral UPS battery backup (****optional for ThruScan s3/s6***) supply to protect the WTMD from power fluctuations and to maintain operation for up to 2 hours (longer times optional) in case of mains failure. The WTMD automatically shuts itself down in case of lack of required voltage.

Another unique feature of the *ThruScan* sX/sX-i/sX-WP is its ability to monitor up to 99 separate (**** for ThruScan s3/s6/s9 sixteen WTMDs for 1 PC***) *ThruScan* units remotely from a PC or even remotely from anywhere in the world via a standard and satellite(thuraya) telephone lines under a modem connection. The hardware for this feature is built in as a standard and the SCADA software and connection cables are available separately as an option. See Section 7.1

Other features of the *ThruScan* include superior sensitivity, stability and silent operation ability. All electronic components are built into the overhead Control Unit. Connection with the side panels are done with sockets, reducing problems often associated with cable-connected console and simplifying required intervention in case of a breakdown.

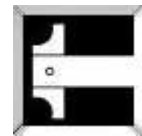

1.1 *ThruScan* s3

- International Norms (NILECJ-0601.00 L1-3 / IP20/TS EN 60950-1, in accordance with CE and produced under ISO 9001: 2008 QMS
- MULTIZONE, 3 "Real Detection Zones" (Left, Middle, Right),
- Auto Calibration,
- Compact Design,
- VLF Technology- human friendly certification,
- Green/Red Bicolour Traffic Through LEDs,
- 10 Sensitivity Levels, 246 adjustable levels at each, applicable to all zones, separately + 1 standard pre-set international security program,
- Graphic Zone Display on control panel,
- Display of Metal Density at 10 levels (green/yellow/red) VU meter,
- Environmental Magnetic Noise Level Display,
- 10 different and 10 level adjustable warning tones,
- Alarm Counter,
- In Counter(one way) at 5 Digits (Visible/Invisible),
- 4 Digit changeable PIN CODE,
- Automatic Failure Display,
- Reloading the Factory Default Settings by 1 touch button,
- Easy Programming & Monitoring with LCD display
- Standard MENU in 4 Languages (English, German, Turkish and Spanish),
- Additional NO/NC Relay Output for peripheral security apparatus as turnstiles, cameras, recorders etc. during alarming
- Switching Power Supply, (**option UPS*).
- Modem/RS232 Output, for Remote Data Communication (**SCADA SOFTWARE**),
- Unique Designs & in variety of colours,
- Easy mounting/dismounting in aprx.15 minutes,
- With the Outdoor Package can be used outside (**optional*),
- Exported to 4 continents.



NOTE: You may access [ThruScan](http://www.elektral.com.tr) s3 Photo Gallery through www.elektral.com.tr website.

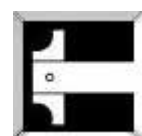

1.2 **ThruScan s6**

- International norms (NILECJ-0601.00 L1-3/IP20/EN60950-1) in accordance with CE and produced under ISO 9001: 2008 QMS
- MULTI-ZONE 6 Real Matrix Detection Zones (Up/Middle/Down & Left/ Right)
- Modular Design
- Auto Calibration (Automatically calibrates itself up to Environmental Conditions)
- Human friendly VLF technology (Certified)
- Green/red bicolor traffic through Lights on Control Unit and Light Indicators at Control Panel
- 10 sensitivity levels, 246 adjustable steps at each + 1 standard pre-set international security program
- Superior Discrimination, Precise target location identification (No false alarms... vey low rate..)
- Graphic Zone Display & Display of metal density at 10-level-VU meter with green/yellow/red LEDs
- Environment magnetic noise level detection display on LCD Screen
- Integrated high-tech filter circuitry eliminates magnetic&electrical interference
- Alarm counter
- 5 Digit Incoming counter (Visible/invisible)
- 4 Digit changeable digital PIN CODE
- Automatic Failure Display
- Reloading the factory default settings by one-touch button
- Easy programming and monitoring with LCD display
- Standard menu in English, German, Spanish and Turkish
- Relay output for recording CCTV, controlling turnstiles, etc. on Alarms
- Adjustable audio alarm at 10 tons/level
- OPTIONAL - Modem and RS232 output for SCADA remote data communication- Send Receive-Change settings by direct cable or modem over Telecom Lines by PC- Audible & Visual alarms can be monitored by PC and can be logged into Hard Disk. Software Optional
- Certificate approved "Safe for wearers of pacemakers and pregnant women" – No effect to magnetic media (eg. Memory sticks, tape, proximity cards)
- Easy-to-mount and assemble walk through metal detector (15 minutes) / No necessity for maintenance
- Unique Compact design-Grey color
- Exported to more than 70 countries / Customer Specifications and OEM / ODM orders welcome



*NOTE: You may access **ThruScan s6** Photo Gallery through www.elektral.com.tr website.*

1.3 *ThruScan s9*

ThruScan s9 was chosen, "The Best Deal" in Dubai Safety Exhibition-2001, with the norms it provides, its specifications, performance and economic advantages. Here are some of the technical superiorities for *ThruScan s9* :

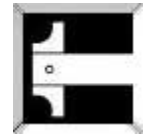

- **International Norms (NILECJ-0601.00 L1-5 / IP44, EN60950-1) in accordance with CE and produced under ISO 9001: 2008 QMS**
- **MULTI-ZONE, 9 Real Matrix Detection Zones**
- **Auto Calibration,**
- **Compact Design,**
- **VLF Technology- human friendly certified,**
- **Green/Red Bicolour Traffic Through LEDs,**
- **LED Illuminated Warnings at the Control and Side Panels,**
- **10 Sensitivity Levels, 246 adjustable levels at each, applicable to all zones, separately + 1 standard pre-set international security program,**
- **Graphic Zone Display on control unit,**
- **Display of Metal Density at 10 level (green/yellow/red) VU meter,**
- **Environmental Magnetic Noise Level Display,**
- **10 different and 10 level adjustable warning tones,**
- **Alarm Counter,**
- **In & Outgoing Counters separately at 5 Digits (Visible/Invisible),**
- **Mechanical lock for control panel and 4 digit changeable PIN CODE,**
- **Automatic Failure Display,**
- **Reloading the Factory Default Settings by 1 touch button,**
- **Easy Programming & Monitoring with LCD display**
- **Standard MENU in 4 Languages (English, German, Turkish and Spanish),**
- **Additional NO/NC Relay Output for peripheral security apparatus as turnstiles, cameras, recorders etc. during alarming,**
- **UPS-Uninterrupted Switching Power Supply, 2 Hours operation without mains,**
- **Modem/RS232 Output, for Remote Data Communication (SCADA SOFTWARE),**
- **Unique Designs & in variety of colours,**
- **Easy mounting/dismounting in approx.15 minutes,**
- **With the Outdoor Package can be used at outside (*optional),**
- **Exported to 4 continents.**



NOTE: You may access [ThruScan s9 Photo Gallery](http://www.elektral.com.tr) through www.elektral.com.tr website.

1.4 ThruScan sX

ThruScan sX was introduced as "The Breaking News" at Abu Dhabi – Middle East Security & Safety Exhibition-2003 with its innovative superior spec, compliance to norms, contemporary design, performance and economic advantage, in comparison to its counterparts. It's widely used and preferred all around the world, protecting millions of people against terrorism.

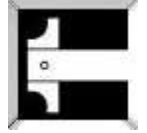

- **International Norms (NILECJ-0601 L1-5 / IP44/TS EN 60950-1) in accordance with CE and produced under ISO 9001: 2008 QMS**
- **MULTI-ZONE, 9 Real Matrix Detection Zone,**
- **Auto Calibration,**
- **VLF Technology- human friendly,**
- **Green/Red Bicolour Traffic Through LEDs,**
- **LED Illuminated Warnings at the Control and Side Panels,**
- **20 Sensitivity Levels, 246 adjustable levels at each, applicable to all zones separately, fixed NILECJ – sensitivity level, 7 fixed International Sensitivity Standard Programmes,**
- **Separate Zone Sensitivity Settings,**
- **Automatic Sensitivity Program selects the correct sensitivity for a specific weapon or test object-(fast consistent calibration) "SMART DETECTOR",**
- **Graphic Zone Display,**
- **Display of Metal Density at 10 level (green/yellow/red) VU meter,**
- **Environment Magnetic Noise Level Display,**
- **10 different and 10 level adjustable warning tones,**
- **Alarm Counter,**
- **In & Outgoing Counters separately at 5 Digits (Visible/Invisible),**
- **Mechanical Lock For Control Panel and 4 Digit changeable PIN CODE,**
- **Automatic Failure Display,**
- **Reloading the Factory Default Settings by 1 touch button,**
- **Easy Programming & Monitoring with LCD display,**
- **Standard MENU in 5 Languages (English, German, Turkish, Arabic and Spanish),**
- **Additional NO/NC Relay Output for peripheral security apparatus as turnstiles, cameras, recorders etc. during alarming,**
- **UPS- Uninterrupted Switching Power Supply, 2 Hours operation without mains,**
- **Modem/RS232 Output, for Remote Data Communication (SCADA SOFTWARE),**
- **Modern, Contemporary, Elinno/Innovative Design,**
- **Unique Designs & in variety of colours,**
- **Easy mounting dismounting (15 Min.),**
- **With the Outdoor Package can be used at outside (*optional),**
- **Exported to 4 continents.**



*NOTE: You may access **ThruScan sX** Photo Gallery through www.elektral.com.tr website.*

1.5 **ThruScan sX-WP** Walk Through Metal Detector for Outside Use

All its features are compatible with **ThruScan** sX model and measures have been taken to comply with IP 55 protection on the electronic module and panels. Advanced measures have been taken against natural events such as rain, snow and sun. This is a **ThruScan** sX model that has special protection complying with international norms, providing robustness outside and security inside.

- **International Norms (NILECJ-0601.00 L1-5 / IP55/ TS EN 60950-1) in accordance with CE and produced under ISO 9001: 2008 QMS**
- **IP 55 – For Outdoor Usage,**
- **MULTI-ZONE, 9 Real Matrix Detection Zone,**
- **Auto Calibration,**
- **VLF Technology- human friendly certified,**
- **Green/Red Bicolour Traffic Through LEDs,**
- **LED Illuminated Warnings at the Control and Side Panels,**
- **20 Sensitivity Levels, 246 adjustable levels at each, applicable to all zones separately, 7 fixed International Sensitivity Standards,**
- **Separate Zone Sensitivity Settings,**
- **Automatic Sensitivity Program selects the correct sensitivity for a specific weapon or test object- (fast consistent calibration) "SMART DETECTOR"**
- **Graphic Zone Display,**
- **Display of Metal Density at 10 level (green/yellow/red) VU meter,**
- **Environment Magnetic Noise Level Detection Display,**
- **10 different and 10 level adjustable warning tones,**
- **Alarm Counter,**
- **In & Outgoing Counters separately at 5 Digits (Visible/Invisible),**
- **Mechanical Lock For Control Panel and 4 Digit changeable PIN CODE,**
- **Automatic Failure Display,**
- **Reloading the Factory Default Settings by 1 touch button,**
- **Easy Programming & Monitoring with LCD display,**
- **Standard MENU in 5 Languages (English, German, Turkish, Arabic and Spanish),**
- **Additional NO/NC Relay Output for peripheral security apparatus as turnstiles, cameras, recorders etc. during alarm,**
- **UPS- Uninterrupted Power Supply, 2 Hours operation without mains,**
- **Modem/RS232 Output, for Remote Data Communication (**SCADA SOFTWARE**),**
- **With/Without Cable connection 30 cm tandem operation of multiple WTMDs,**
- **Power Supply; Switching Mode Power Supply (SMPS), low voltage usage feature,**
- **Unique Designs & in variety of colours, Modern, Contemporary, *Elinno*/Innovative Design,**
- **Easy mounting /dismounting (15 Min.),**
- **Exported to 4 continents.**



*NOTE: You may access **ThruScan SX-WP** Photo Gallery through www.elektral.com.tr website.*

1.6 **ThruScan s15-i**

- International Norms (NILECJ-0601.00 L1-5/ IP44/TS EN 60950-1), ECAC.CEAC DOC 30 Compliance, in accordance with CE and produced under ISO 9001:2008 QMS
- MULTI-ZONE 15 Real Matrix Detection Zones,
- Auto Calibration,
- VLF Technology- human friendly certified,
- Green/Red Bicolour Traffic Through LEDs,
- LED Illuminated Warnings on the Control Panel and Continuous LED's on Side Panels,
- 20 Sensitivity Levels, 246 adjustable levels at each, 10 fixed International Sensitivity Standards, Jailhouse Detection Sensitivity availability
- Separate Zone Sensitivity Settings,
- Automatic Sensitivity Program selects the correct sensitivity for a specific weapon or test object (fast consistent calibration) "SMART DETECTOR"
- Precise target location LED Graphic Zone Display,
- Display of Metal Density at 10 level (green/yellow/red) VU meter,
- Environment Magnetic Noise Level Detection Display,
- 10 different and 10 level adjustable warning tones,
- Record Statistics of Operation Duration, Number of Visitors and Alarms (Real/Random Alarms Separately)
- In & Outgoing Counters separately at 5 Digits (Visible/Invisible),
- Mechanical Lock For Control Panel and 4 Digit changeable PIN CODE,
- Automatic Failure - Error Code Display ,
- Adjustable Alarm Duration (0,5s-2s),
- IR Protection Feature enabling perfect low false alarm operation/ Continuous Detection Mode Selection Enabled
- Reloading the Factory Default Settings by 1 touch button,
- Easy Programming & Monitoring with LCD display,
- Standard Menu in 5 Languages (English, German, Turkish, Arabic and Spanish),
- Additional NO/NC Relay Output for peripheral security apparatus as turnstiles, cameras, recorders etc. during alarming,
- UPS- Uninterrupted Power Supply, 2 Hours operation without mains,
- With/Without Cable connection interference free tandem operation of two WTMDs at a distance of min. 5 cm
- RS232 Output for **SCADA Remote Control Software** - Send Receive- Change settings by PC, Audio-Visual alarms can be monitored Real Time by PC and can be logged into Hard Disk *Software Optional*
- Audio-Visual alarms are noticeable at a range of 4 meters
- Adjustable Random Alarm feature to give alarm for clean visitors at a selected ratio.
- Option: Outdoor usage capability with the Optional Outdoor Pack



You may access **ThruScan s15-i** Photo Gallery through www.elektral.com.tr website.

1.7 *ThruScan* sX-i

- International Norms (NILECJ-0601.00 L1-5/NIJ0601.02/IP65/TS EN 60950-1, EN60068, 60529), ECAC.CEAC DOC 30 Standard 2 Compliance, in accordance with CE and produced under ISO 9001:2008 QMS
- MULTI-ZONE 9 Real Parallel Detection Zones,
- Auto Calibration
- VLF Technology human friendly certified,
- Contemporary Lines, Compact and Peculiar Elinno Design
- Human friendly VLF technology (Certified)
- Green/Red bicolour traffic through LED's allow easy sight from a distance
- Continuous LED Zone Alarm Light indicator on side panel from top to bottom
- 25 Sensitivity Levels, 246 adjustable levels at each, 10 fixed International Sensitivity Standards, Jailhouse Detection Sensitivity availability
- Separate Zone Sensitivity Settings
- SMART DETECTOR Fast and consistent calibration, Automatic Sensitivity Program selects the correct sensitivity for a specific weapon or a test object
- Superior Discrimination, Precise target location identification / Graphic zone display
- Metal Density-Mass, Signal Strength Display at 10-level-VU meter with green, yellow, red LEDs easily allow sight from a distance
- Digital Environment magnetic noise level and visual detection display on LCD Screen
- Adjustable audio alarm at 10 tones/level or Soundless (Mute) operation.
- Record Statistics of Operation Duration, Number of Visitors and Alarms (Real/Random Alarms Separately)
- Five Digit IN/OUT Traffic Counters (Visible/Invisible)
- Mechanical Lock for control panel and 4 Digit changeable digital PIN CODE
- Automatic Failure Error Code Display Function
- Adjustable Alarm Period (0,5 s-2s)
- IR Protection Feature enabling perfect low false alarm operation/ Continuous Detection Mode Selection Enabled
- Reloading the factory default settings by one-touch button
- Easy programming and monitoring with wide LCD display
- Standard menu in English, German, Spanish, Arabic and Turkish
- Relay outputs for recording CCTV, Photo Taken-Recording, controlling turnstiles, etc. on Alarms
- Standard Uninterruptible Power Supply (UPS) enabling 2 hours operation without mains
- With/Without Cable connection interference free tandem operation of two WTMDs at a distance of min. 5 cm
- RS232 Output for **SCADA Remote Control Software** - Send Receive- Change settings by PC, Audio-Visual alarms can be monitored Real Time by PC and can be logged into Hard Disk *Software Optional*
- Audio-Visual alarms are noticeable at a range of 4 meters
- Adjustable Random Alarm possibilities to give alarm for clean visitors at a selected ratio.
- Option: Outdoor usage capability with the Optional Outdoor Pack



NOTE: You may access *ThruScan* sX-i Photo Gallery through www.elektral.com.tr website

2 INSTALLATION



2.1 TRANSPORTATION AND SITE SELECTION

ThruScan WTMDs are being packed and shipped in two separate boxes "Control Unit" and "Side Panels". Control Unit, Back Fixing Crosspiece and screws with Allen Keys are packed in the Control Unit Box (*Only for ThruScan/s3/s6/s9). Side Panels and Floor Fixing Metal Plates are being packed in the Side Panels Box. During transportation the Position Signs indicating upside on the Boxes have to be taken into account for the equipment to be delivered correctly. Improper transportation may result in physical damages on your equipment. When there is a need to relocate the WTMD, the WTMD has to be unassembled, packed and delivered as described above before assembling again.

Before choosing a site for **ThruScan**, it is important to consider the volume and throughput of pedestrian traffic, space availability and overall environmental conditions.

Position and fix **ThruScan** on a flat, stable floor where it remains unaffected by the sun, rain, mist or condensation. If the WTMD will be used for a short time in outdoor then use "Rain Protect Shelter (Hat)" as well as outdoor package. (See Section 7.2). **ThruScan** sX-WP is produced for outdoor fulfilling IP55 standards.

To avoid external metal interference, ensure that there are no large metal items near **ThruScan**. False alarms may be caused by nearby moving metallic objects such as an escalator or a revolving door as well as due to an electrical interference from radio, telephones, television monitors, powerful electronic motors and transformers.

Electrical installation of the WTMD should be from the ceiling.

Protect your WTMD from humidity and water since it is versatile electronic equipment or use our Weather proof Model.

2.2 ASSEMBLING & MOUNTING

ThruScan WTMDs are designed for easy installation by the end users. Assembly can be done easily by proceeding the below mentioned procedures. Also the Manufacturers contact details are provided in this User's Manual for further communication needs.

2.2.1 Verify that the following contents are included:

- ✓ Left side panel
 - ✓ Right side panel
 - ✓ Main control & display unit
 - ✓ Back fixing crosspiece*
 - ✓ Mains power cord
 - ✓ Synchronization connection cable**
 - ✓ Rain Shelter***
 - ✓ 4 floor fixing screws
 - ✓ 8 panel fixing bolts
 - ✓ 8 plastic bolt covers
 - ✓ Installation spanner (for panel fixing bolts)
 - ✓ Allen key (for floor fixing plates)
 - ✓ User's manual
- (*only for ThruScan s3/s6/s9)
(**optional)
(***only for ThruScan sX/WP)

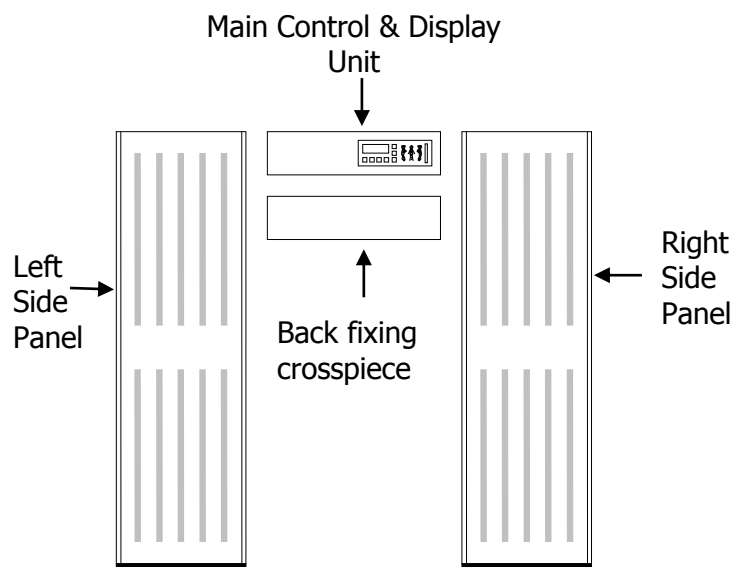

2.2.2 Arrange the major components as shown above.

2.2.3 Lay the main Control Unit (*with the control panel facing down*) onto a soft, scratch free surface (*the packing (bubbled pe) is ideal*).

2.2.4 Remove the rear panel of the main Control Unit by undoing the two small fixing screws. Retain these screws to screw them back in their places later

(Note: The arrow signs on the control unit and the panel parts, which are fixed on the top of each other, have to point to the same direction).

2.2.5 Using the Eight Panel Fixing Bolts (4 on each side), screw two side panels to "Control Unit" (***ThruScan*** s3/s6/s9 two Screws on each panel) do not fully tighten at this stage.

2.2.6 Plug in the side panel connectors to the main Control Unit (take the numbers written on them [sX-i] in consideration) as follows:

- Left Side Panel – Connect the Side Panel Sockets in to the connector of the Control Unit (ThruScan s3/s6/s9 models have two sockets)
- Right Side Panel – Connect the Side Panel Socket to the Connector on the Control Unit

Note: This WTMD is designed to prevent false connector/socket connection.

2.2.7 Place back the rear panel of the main Control Unit using the three small fixing screws previously removed (*see 2.2.4 above*).

2.2.8 Attach the back fixing crosspiece using the remaining four panel fixing bolts (only ***ThruScan*** s3/s6/s9); **do not fully tighten at this stage.**

2.2.9 Remove four hex bolts holding the floor fixing plates at the bottom of each side panel using the Allen key.

2.2.10 Use two or more people to lift your WTMD carefully to a vertical position and move to desired location. Ensure the two side panels are perfectly aligned parallel to each other with 74cm spacing between panels.

CAUTION! The WTMD will not operate fully functional if the side panels and the infrared sensors are not aligned properly.

2.2.11 Carefully mark the Side Panel Erection Positions on the floor, and fix the floor fixing metal plates onto the floor. Put the WTMD Side Panels into floor fixing plates making sure the plates will fit inside the Side Panels, using Allen key (*see 2.2.9 above*) tighten the plates only to prevent from moving; DO NOT over tighten. Stabilisation for ThruScan Sx-i model can be done using the holes at the tip of each foot.

2.2.12 Ensure that ***ThruScan*** is physically stable.

2.2.13 Fully tighten all bolts with the installation spanner.

2.2.14 Finally, ensure that the Mains Power Cord is connected to the Connector at the back of the Control Unit.

3. CONTROL (DISPLAY) PANEL & INDICATION INFORMATION



The control panel functions are protected from unauthorized tampering by a lockable see through control cover in the overhead main Control Unit. Operators should not normally need to adjust these controls, which should only be altered by a supervisor or manager in order to change the sensitivity settings of *ThruScan*, reset counters, perform installation adjustments and to switch the unit on /off etc.

3.1 CONTROL PANEL

The control display panel provides a visual indication of the status of the unit as well as all controls necessary for the programming and operation of the unit. The following features can be found on the display panel.

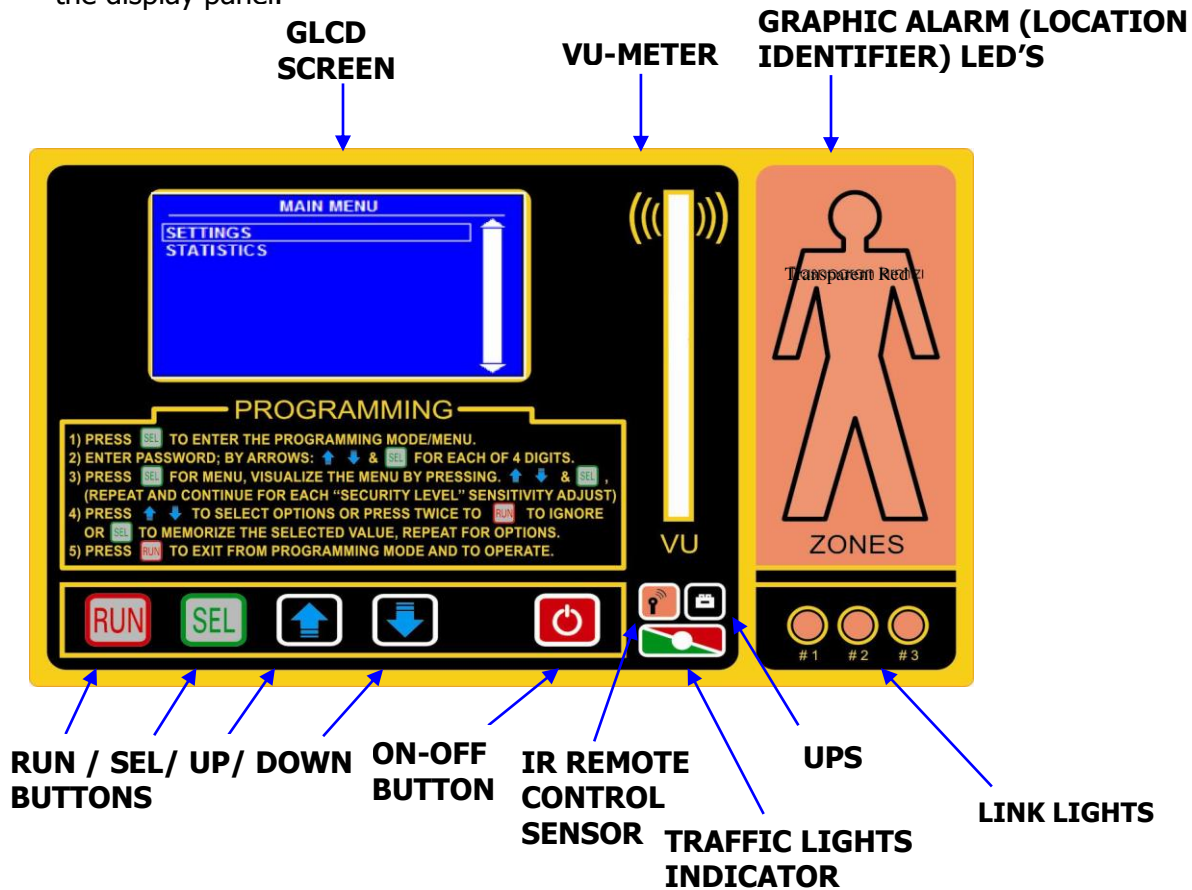

3.1.1 LCD (LIQUID CRYSTAL DISPLAY-SCREEN)

The LCD is an ongoing visual display located in the overhead Control Unit. The LCD displays the security level settings and traffic count of both incoming and outgoing traffic. The display also provides operational information, including program settings and adjustment information together with fault indication and alarm displays.

3.1.2 GRAPHIC (ALARM) ZONE LED's (LOCATOR)

The display panel gives a graphical indication of the area of any alarm activation by indicating whether the point of detection is on the right, left or centre of the body and also whether it is at a high, middle or low level.

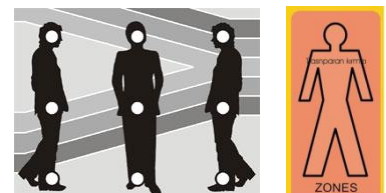

3.1.3 VU Display (LED array)

The LED VU comprises of five green, three yellow and three red LED's providing a graphical indication of the level of metal detection activity occurring within the archway. The degree of detection intensity varies depending on the quantity and composition of the metallic object(s).



Note: WTMD and thus the VU display will only operate whilst the infrared beam is obstructed.

CAUTION! the first (green) led only indicate that the WTMD is on but not any operational detection situation.

3.1.4 UPS INDICATOR

When the Mains Voltage is cut off the WTMD will continue to operate with power from the Battery, the battery mode operation indication will be continuously active (yellow LED); if the battery voltage drops under a certain level the Yellow LED indicator will start flashing; and if the battery Voltage will no longer enable WTMD Operation, the Yellow LED indication will be flashing Continuously, there will be an intermittent audio alarm tone and then the WTMD will then automatically shut down itself.



3.1.5 IRDA REMOTE CONTROL RECEIVER

(*only for ThruScan sX/ s15-i/sX-i)

It is the receiving LED of the pilot Remote Control Unit.



3.1.6 TRAFFIC INDICATOR LEDS (LIGHTS)

The Traffic Light simulation on Side Panels and the Control Unit enables the Security Staff to decide whether the WTMD is ready for detection and the passage is empty. Green indicates "Walk", Red indicates "Stop".



3.2 TOUCHPADS

A total of five touchpad controls are located on the control unit as follows;

3.2.1 ON - OFF BUTTON

The **ON-OFF** touchpad button turns the WTMD on and off. At each start up a 10 second self test is being carried out, and during this time a 'test tone' will be heard. Please wait for 1 minute after switching on before using the gateway in order to allow the auto-calibration program to designate/memorize for metal objects around its environment.



You can Turn Off your WTMD by pressing the ON-OFF button for 2 seconds and release. The previous settings and adjustments would be stored when you turn off your WTMD and will be displayed when turned on again.

3.2.2 RUN(X) BUTTON

The **RUN(X)** touchpad button returns the WTMD to **RUN(X)**/operation mode after any programming changes are made using the **SEL(√)** button. It is also used as an "ESC" button when no changes are made.



3.2.3 SEL(✓) BUTTON

The **SEL(ect)** touchpad button is to access and enter the programming modes and to confirm programming changes.



3.2.4 UP&DOWN BUTTONS

The **UP&DOWN** touchpad buttons are used for moving up and down through the programming options when in the MENU and the programming mode.



3.3 TRAFFIC LIGHTS

Location of the Traffic lights may vary as per different models. At the entrance part of the Two Side Panels (*ThruScan* s9), at the Entrance Part of the Control Unit (*ThruScan* sX/sX-WP/s15-i/sX-i), under the Control Unit (*ThruScan* s3/s6). These bi-color lights indicate if the archway is ready to control the passage.



- The green light indicates "Walk".
- The red light indicates "Stop".

3.4 ZONE (INDICATOR) LIGHTS (*)

ThruScan Walk-Through Metal Detectors have Zone Display LED's (LED ARRAY) on Both Side Panels continuously from the bottom part of the detection area to the top. These LED Arrays help the operators pinpoint the detected metal objects throughout the WTMD Passage.

(*) *ThruScan* s3/s6 models do not have this feature, but they do have Graphic Zone LED's on the control panel.

WARNING: In case of a power cut, *ThruScan* continues operation with its internal power supply. Zone-lights will shut down automatically to save energy after a certain period of time during power failure. Graphic Display on Control Panel will indicate the location of threat zone.

3.5 VARIOUS ALARMS

Both the supervisor and the operator should be familiar with the *ThruScan*'s audio & visual alarms.

The unit will generate an alarm condition to indicate that a sufficient amount of metal (according to the program and sensitivity settings) has been detected; Special built-in filtering circuits help to suppress excess electronic noise signals from a variety of sources, including X-ray monitors, horizontal synchronisation and closed-circuit television/CCTV, etc..



Metal detectors sometimes generate false alarms, triggered by nearby metal objects or interference from electrical or mechanical environmental noise from large motors, computers, fluorescent

lighting or other sources. The *ThruScan*'s infrared sensors are a feature that helps to minimise the audible false alarms by ensuring that an alarm activates only if a person passes through the archway.

Rarely a false source, such as a person passing and bumping to the archway, may also trigger the alarm.

CAUTION! The operator must never dismiss a false alarm since there may be the possibility of a professional terrorist person to create a false alarm by bumping and thus creating confusion.

3.6 RELAY CONTACT OUTPUTS (RJ11/12)

Relay contacts (for phone connector) are present on *ThruScan* (on the side panel or on the control unit). This feature provides the control and use of peripheral equipment such as CCTV, Camera, Turnstiles, Gates, etc...



These contacts; **((RJ11/12) can be used for 24 VDC/2 Amps.)**



- 1- NO (Normally Open)
- 2- NO (Normally Open)
- 3- Common
- 4- Common
- 5- NC (Normally Closed)
- 6- NC (Normally Closed)

*** Contact numbers of the socket are coded as they appear on the picture / WTMD from left to right.

CAUTION! Relay Output does not function with "Real-Time Video Prosecution Unit" equipped Walk-Through Metal Detectors.

3.7 SYNCHORNIZATION AND REMOTE CONTROL OUTPUTS (RJ11/12)

This socket (for phone connector)*** is for two or more WTMDs to be used in tandem and/or for remote control by using the direct cable or a modem via phone line. See Section 6.13 and Section 7.1



- 1- Transmitter1
- 2- Transmitter2
- 5- Ground/Earth (Norm)
- 6- RS 232

*** Contact numbers of the socket are coded as they appear on the WTMD from left to right.

4. PROGRAMMING & SET UP



Programming and set up can be performed as follows after the password is entered using the touch pad on the control panel:

NOTE: Default Password for all ThruScan WTMD's is " 0000 ". If the optional Real Time Video Prosecution Unit is being used, the password must not be set up as " 8888 ".

NOTE: The password should only be known and entered by the authorized personnel. Only one person should hold responsibility for procedures requiring the password. The operator should only be in charge of operating ThruScan and do the security control.

4.1 PROGRAMMING MENU

To enter the programming MENU press the **SEL(√)** button once.



The LCD display will change and show: **"ENTER PASSWORD"** on the screen.

To be able to enter the programming MENU the correct four-digit user code must now be entered as follows:

1. Select the 1st digit of the user code by using the **UP&DOWN** buttons – Then press **SEL(√)**;
2. Select the 2nd digit of the user code by using the **UP&DOWN** buttons – Then press **SEL(√)**;
3. Select the 3rd digit of the user code by using the **UP&DOWN** buttons – Then press **SEL(√)**;
4. Select the 4th digit of the user code by using the **UP&DOWN** buttons – Then press **SEL(√)**;

If the correct code has been entered the display will change and show: **"MAIN MENU"** followed by the menu selections underneath.

All settings can be done in the "SETTINGS" menu. Statistics can be viewed in the "STATISTICS" menu. Use **UP&DOWN** buttons – Then press **SEL(√)** to enter the desired menu.

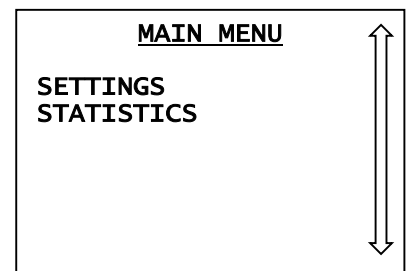

If the incorrect code has been entered the display will momentarily change to show: **"PASSWORD ERROR"** and return to the normal operating display.

NOTE: Contact your dealer or the company with the serial number of your ThruScan or your invoice information if you forget your password.

Use **UP&DOWN** buttons – Then press **SEL(√)** to enter the desired section in the menu. To exit without saving press the **RUN(X)** button, to save and exit press the **SEL(√)** button.

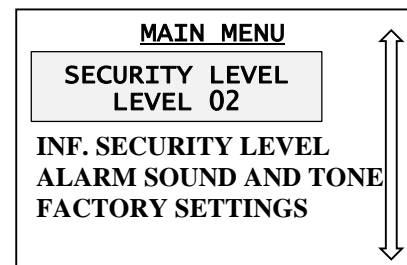

4.1.1 SECURITY LEVEL & SENSITIVITY LEVEL ADJUSTMENTS

ThruScan s3-s6-s9 :

Consisting of 10 separate security levels (channels), each security level (except for NC levels) can be set to operate at a different sensitivity level. It is possible to adjust a total of 246 sensitivity levels from security level 000 (the highest sensitivity) to 245 (the lowest sensitivity).

ThruScan sX/sX-WP/s15-i/ sX-i :

Consisting of 20/25 separate security levels (channels), each security level (except for NC level) can be set to operate at a different sensitivity level. 7 / 10 Fixed International Sensitivity Standards (optional). It is possible to adjust a total of 247 sensitivity levels from security level 000 (the highest sensitivity) to 246 (the lowest sensitivity). In this very distinctive feature ; The security Level is defined and assigned by the AD-Auto Designation technique and consequently the relative, pre-selected "Security Level/Channel" is set. See Section 4.1.3 for further details.

1. To choose the security level required use **UP & DOWN** buttons then press the **SEL(✓)** button
2. To assign factory settings value or the selected value to the security level press the **SEL(✓)** button
3. If " DEFAULT " is selected automatic assignment occurs and the detector returns to the previous menu
4. During " MANUEL " selection, use **UP & DOWN** buttons to adjust the security level required then press the **SEL(✓)** button.

SECURITY LEVEL	
LEVEL 1	010
LEVEL 2	020
LEVEL 3	030
LEVEL 4	040
LEVEL 5	050
LEVEL 6	060

NEW VALUE	
MANUAL	
DEFAULT	050

NEW VALUE
050

Factory default settings Security Levels for *ThruScan s3/s6/s9* and *ThruScan sX/ sX-WP /s15-i/sX-i* are as follows:

<i>ThruScan s3/s6/s9 :</i>		<i>ThruScan sX/ sX-WP /s15-i/sX-i:</i>	
SECURITY LEVEL	SENSITIVITY ADJUSTMENT	SECURITY LEVEL	SENSITIVITY ADJUSTMENT
Security Level 1	010	Security Level 01	010
Security Level 2	020	Security Level 02	020
Security Level 3	030	Security Level 03	030
Security Level 4	050	Security Level 04	040
Security Level 5	100	Security Level 05	050
Security Level 6	140	Security Level 06	060
Security Level 7	180	Security Level 07	070
Security Level 8	220	Security Level 08	080
Security Level 9	230	Security Level 09	000
		Security Level 10	100
		Security Level 11	110
		ENTER. CENTER	050
		MALL	050
		PUBLIC B.	010
		AIRPORT 1	000
		AIRPORT 2	020
		PRISON	000
		AD-Auto Designation	020 –Auto D /AD See 4.1.3
		ECACSTD1	***
		ECACSTD2	***
		ECACSTD3	***
		NIJ 0601.02 SMALL	***
		NIJ 0601.02 MEDIUM	***
		NIJ 0601.02 LARGE	***
		NILECJ	***

The preset security levels are designed to cover most eventualities for easy programming of your WTMDs. Jailhouses, Airports 2 (Entrance Gate), Airports 1 (Boarding Gate), Government Buildings, Shopping Centres, Entertainment Venues. **However, these pre-set Security Levels are only recommendations for user’s convenience. Owners/Operators of the Metal Detectors must adjust the sensitivity as per requirements and their security concerns.** If local situation or circumstances require fine tuning the sensitivity of any security level (except NIJ) may be altered as follows:

1. Once the correct user code has been entered the display will turn to program mode and show the current security level. To change the selected security level proceed with the following;
2. Press the **SEL(✓)** button once – The display will change to show the current security level number e.g. **Level 3**

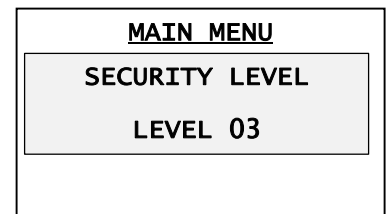

3. Select the required security level by using the **UP&DOWN** buttons – Then press **SEL**,
4. The display will change to show the current sensitivity setting for that security e.g. **Level 5 050**
5. To change the sensitivity setting use the **UP&DOWN** buttons until the desired setting is reached – Then press **SEL**,
6. The new sensitivity level will be stored and the display will return to show the current security level number as above.

SECURITY LEVEL	
LEVEL 5	050

NOTE: The sensitivity setting on security level NC is fixed according to NILECJ – Level 2 and cannot be altered.

The above procedure can be repeated for each security level, by repeating points 2 – 5 as above for any security level requiring to be designated.

When sensitivity adjustments are complete, other programming options may be accessed by pressing the **UP&DOWN** buttons to select the required **sub-MENU** or press **RUN(X)** to return to the normal operating mode.

4.1.2 SECURITY ZONE AND SENSITIVITY LEVEL ADJUSTMENTS (*for ThruScan *sX/ sX-WP /s15-i/sX-i*)

The detection areas for *ThruScan sX/ sX-WP* are divided into 3 sections; bottom zone (ZONE 1), middle zone (ZONE 2) and top zone (ZONE 3). Exclusively the sensitivity level of *ThruScan* can be adjusted separately in each zone. i.e. / the middle zone of *ThruScan* may be adjusted to be more or less sensitive in comparison to the top or the bottom zones.

ZONE	
ZONE 1	10
ZONE 2	20
ZONE 3	30
ZONE 4	40
ZONE 5	50
ZONE 6	60

The detection areas for *ThruScan sX-i* are divided into 9 separate zones from top to bottom and the sensitivity level of each zone can be adjusted separately regardless of each other.

By this feature, the sensitivity level of zone 2 in which there would more likely be keys, cellular phones, belts etc. can be decreased while the other zones' can be increased.

NEW VALUE
050

NOTE: The general sensitivity level adjustments are dominant (pls. see section 4.1.1). Therefore any separate sensitivity level adjustment of the zones will not be valid after such preliminary setting.

4.1.3 AUTO DESIGNATION AND AUTOMATIC SENSITIVITY ASSIGNMENT (* only for *ThruScan sX/ sX-WP /s15-i/sX-i*)

This feature is rare worldwide and its MENU helps the user to decide and to assign the required sensitivity level rapidly.

The assigned sensitivity level in this MENU is approximate. For more precise security requirements, it is recommended that the user decides on the necessary sensitivity level by using the displayed (AD) sensitivity level only as a reference and proceed further adjustments manually.

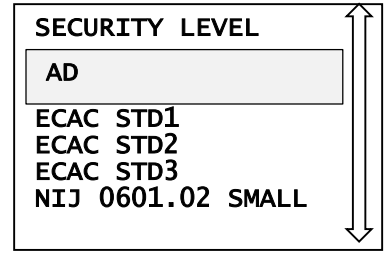

4.1.4 ALARM VOLUME & TONE ADJUSTMENT

ThruScan has 11 separate alarm volume levels, in 10 different tones from 1(quietest) to 10(loudest) as well as 00, which disables the audible alarm tone (but not the visual indication).

The Factory default alarm volume setting is = 05

The Factory default tone setting is = 09

The alarm volume can be set as follows:

1. Press UP&DOWN buttons from the MENU until the ALARM VOLUME sub-MENU option is displayed,
2. Current Alarm Volume will be displayed, (i.e. 05 displayed),
3. Use UP&DOWN buttons to reach the required volume setting,
4. To fix the alarm volume press the SEL(✓) button then "TONE" will be automatically displayed,
5. Use UP&DOWN buttons to reach the required tone type,
6. Press SEL(✓) button to select and fix the setting.

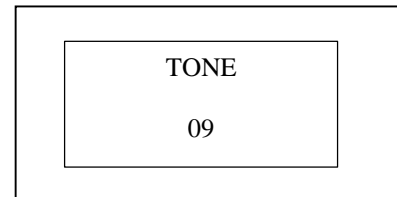
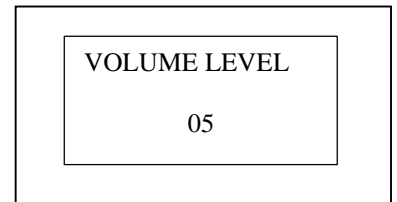
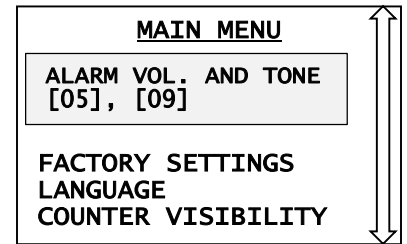

Press **UP&DOWN** buttons to move to the next **sub-MENU** option or press **RUN(X)** button to store the changes and thus return to the normal operating mode.

4.1.5 ALARM COUNTERS

4.1.5.1 FOR; *ThruScan* s3/s6/s9

ThruScan has an internal alarm counter and memory where the number of alarms after a reset are saved. This information can be displayed from "ALARM COUNTER".

The alarm memory can be viewed or reset as follows:

1. Press **UP&DOWN** buttons from the MENU until **ALARM COUNTER** sub-MENU option is displayed.
2. The LCD will display the number of the counted alarms stored in memory;
3. To reset the counter press **SEL(✓)** button to enter the reset MENU,
4. Use **UP&DOWN** buttons to select either **N** (do not reset) or **Y** (reset) the alarm counter,
5. Press **SEL(✓)** button to select and fix the setting.

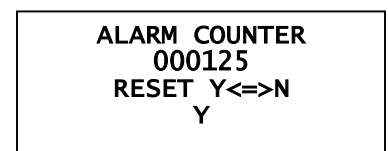
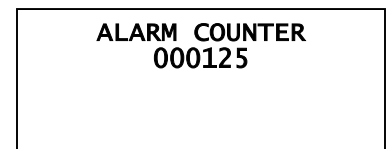

4.1.5.2 FOR; ThruScan sX/sX-WP/s15-i/sX-i

ThruScan s15-i / sX-i counts Alarm and Randomly Generated Alarms separately (Article. 4.1.15). From Left to Right the Menu Displays the Alarm – Random Alarm Counters. When required you can check these counter values by entering ALARM COUNTER Menu.

Counter Values can be displayed in two ways or can be reset to zero.

1. Press **UP&DOWN** Buttons to find Alarm Counter Menu;
2. LCD Displays Alarm Counter Values when entered into Menu
3. To reset the values, press **SEL(✓)** and Enter Menu.
4. Press **SEL(✓)** to save your settings.

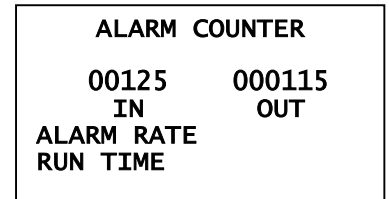
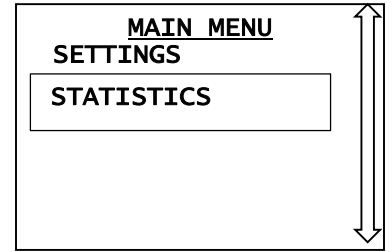

Press **UP&DOWN** buttons and change to the next **sub-MENU** option or press **RUN(X)** button to store the changes and thus return to the normal operating mode.

4.1.6 IN-COMING / OUT-GOING COUNTER (TRAFFIC COUNTS)

4.1.6.1 FOR; ThruScan s3/s6

ThruScan s3/s6 contains an internal counter for transitions from the entrance side. The counter value is displayed on LCD and thus the number of the passings are being controlled from screen.

Counter can be resetted as follows;

1. Find "**COUNTER**" sub-MENU in the MENU by **UP&DOWN** buttons.
2. See Counts that are displayed,
3. To reset counts press **SEL**, and return to MENU,
4. Choose **Y**(yes) or **N**(no) by **UP&DOWN** buttons,
5. Press **SEL(✓)** button to select and fix the setting.



Press **UP&DOWN** buttons to move to the next **sub-MENU** option or press **RUN(X)** button to store the changes and thus return to the normal operating mode.

FOR; ThruScan s9 a traffic counter monitoring both incoming and outgoing traffic through WTMD thus indicates the number of persons passing through the unit in both directions after the last memory "reset".

The IN&OUT counter values are displayed on the LCD (screen) and one can compare the difference between the two counters to find the number of persons still in the building.

The traffic counter memory can be viewed or reset as follows:

1. Press **UP&DOWN** buttons until the **IN<COUNTER>OUT COUNTER** sub-MENU option is displayed,

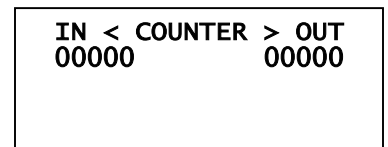

- Counter value stored in the memory will be displayed for both the IN & OUT counters separately,
- To reset the counters press **SEL(√)** button to enter the reset MENU,
- Select either **00** (do not reset), **01** (reset the **IN count**), **02** (reset the **OUT count**) or **03** (reset **BOTH COUNTERS**) by **UP&DOWN** buttons,
- Press **SEL(√)** button to select and fix the setting.

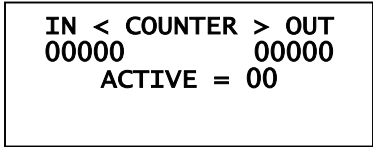

Press **UP&DOWN** buttons to move to the next **sub-MENU** option or press **RUN(X)** button to store the changes and thus return to the normal operating mode.

4.1.6.2 FOR; ThruScan sX/ sX-WP /s15-i/sX-i

ThruScan has a traffic counter monitoring both incoming and outgoing traffic through WTMD thus indicates the number of persons passing through the unit in both directions after the last memory "reset".

The IN&OUT counter values are displayed on the LCD (screen) and one can compare the difference between the two counters to find the number of persons still in the building.

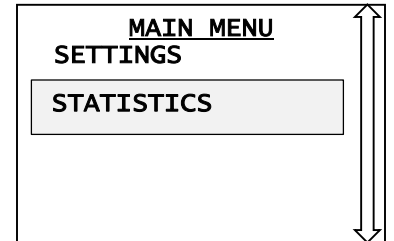

The traffic counter memory can be viewed or reset as follows:

- Press **UP&DOWN** buttons in **STATISTICS** until the **ALARM COUNTER sub-MENU** option is displayed,
- Counter value stored in the memory will be displayed for both the IN & OUT counters separately,
- To reset the counters press **SEL(√)** button to enter the reset MENU,
- The reset of these values can be done here,
- Press **SEL(√)** button to select and fix the setting.

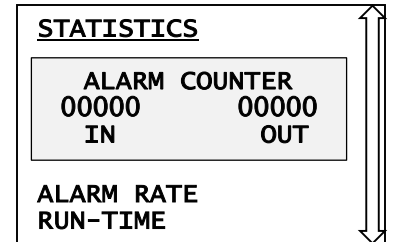

Press **UP&DOWN** buttons to move to the next **sub-MENU** option or press **RUN(X)** button to store the changes and thus return to the normal operating mode.

NOTE: Please ask people who had metal detected on by the WTMD, to walk back through the WTMD so that the in & out counters wouldn't count the same person again and again. This way, the number or the people inside would be accurate. Continuous operation & detection can be obtained when IR Pass Sensor LEDs are obstructed.

4.1.7 FACTORY SETTINGS

ThruScan can be returned to factory settings as follows:

- Press **UP&DOWN** buttons from the MENU until the **FACTORY SETTING sub-MENU** option is displayed.

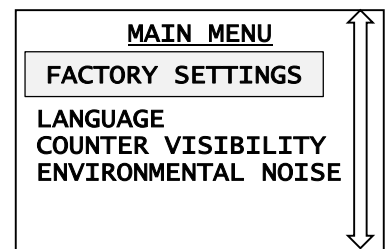

2. To reset return to factory settings press **SEL(✓)** button to enter the factory reset MENU.
3. Use **UP&DOWN** buttons to select **YES** or **NO**.
4. Press **SEL(✓)** button to select and fix the setting.

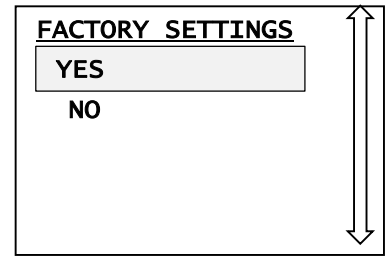

NOTE: The reset to Factory defaults does not alter the in & out counters. Only such displays as the sensitivity adjustments, programs or volume adjustments return to their factory settings. To change the in & out counter's values see Section 4.1.6

Press **UP&DOWN** button to move to the next **sub**-MENU option or press **RUN(X)** button to store the changes and thus return to the normal operating mode.

4.1.8 LANGUAGE SELECTION

English, German, Turkish and Spanish languages (others optional) can be selected to operate *ThruScan* as follows:

1. Press **UP&DOWN** buttons until the **LANGUAGE** sub-MENU option is displayed.
2. To change the language settings press **SEL(✓)** button to enter the language MENU.
3. Use **UP&DOWN** buttons to select the language (English, German, Turkish or Spanish).
4. Press the **SEL(✓)** button to select and fix the setting.

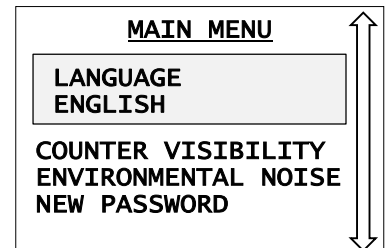

Press the **UP&DOWN** button to move to the next **sub**-MENU option or press **RUN(X)** button to store the changes and thus return to the normal operating mode.

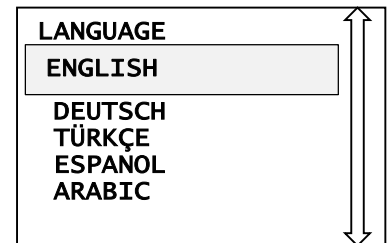

4.1.9 COUNTER VISIBILITY

To display the **IN** and **OUT counter** is as follows:

1. Press **UP&DOWN** buttons until the **COUNTER VISIBILITY** sub-MENU option is displayed.
2. Press **SEL(✓)** button to enter the counter visibility MENU to change the setting.
3. Use **UP&DOWN** buttons to select either **NO (display OFF)** or **YES (display ON)**.
4. Press **SEL(✓)** button to select and fix the setting.

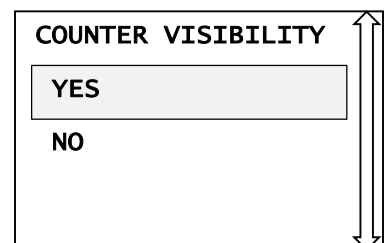
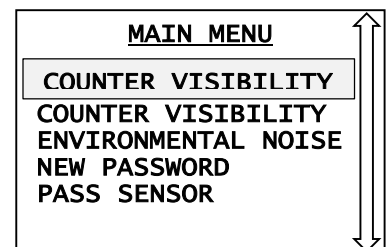

Press **UP&DOWN** buttons to move to the next **sub**-MENU options or press **RUN(X)** button to store the changes and thus return to the normal operating mode.

4.1.10 NEW PASSWORD

A four digit numerical password – **PIN CODE (default factory setting (0000))** secures *ThruScan's* programming and data. This password may be changed at any time as follows;

1. Press **UP&DOWN** buttons until the **NEW PASSWORD** sub-MENU option is displayed.
2. To change the password press **SEL(✓)** button and enter the new password MENU.
3. Select the 1st digit of the new password by using the **UP&DOWN** buttons – Then press **SEL(✓)**.
4. Select the 2nd digit of the password code by using the **UP&DOWN** buttons–Then press **SEL(✓)**.
5. Select the 3rd digit of the password code by using the **UP&DOWN** buttons–Then press **SEL(✓)**.
6. Select the 4th digit of the password code by using the **UP&DOWN** buttons–Then press **SEL(✓)**.

Press **UP&DOWN** buttons and change to the next **sub-MENU** option or press **RUN(X)** button to store the changes and thus return to the normal operating mode.

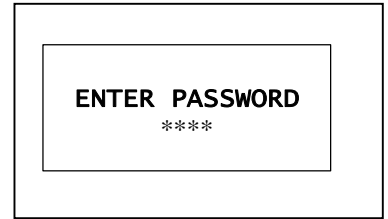
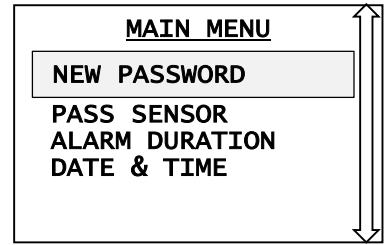

4.1.11 ENVIRONMENTAL NOISE

This MENU is prepared to measure the electromagnetic noise level of surrounding and thus help the user to select the sensitivity level accordingly.

- 1- Press **UP&DOWN** buttons until the **ENVIRONMENT NOISE LEVEL** sub-MENU option is displayed.
- 2- Enter the MENU by pressing **SEL(✓)** button,
- 3- The noise value of the environment will be displayed,
- 4- Return to MENU by pressing **RUN(X)**.

NOTE: People carrying metal objects must not pass through or near the WTMD while carrying out this process.

A higher value than the threshold noise level should be selected for sensitivity level to avoid false alarms depending on the users experience and instinct.

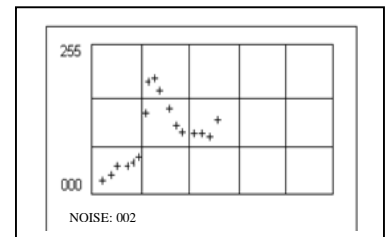
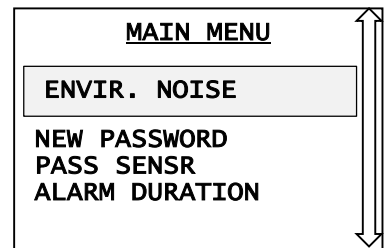

4.1.12 PASS SENSOR
 (*only for ThruScan sX/ sX-WP /s15-i/sX-i)

ThruScan operates to detect only the metals passing through the archway. With this extra feature it is possible to change this condition.

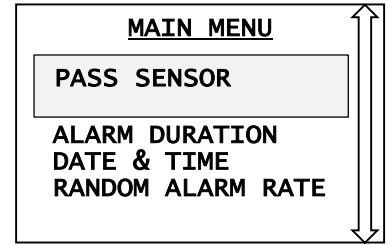

In order to do this perform below steps:

- 1- Find "PASS SENSOR" sub-MENU by **UP&DOWN** buttons,
- 2- Enter the MENU by pressing **SEL(√)** button,
- 3- Select your alternative with **UP&DOWN** buttons as;
 * **NO** to shut PASS SENSOR. (passing is not necessary for detection) or vice versa.
- 4- Return to MENU by pressing **RUN(X)**.

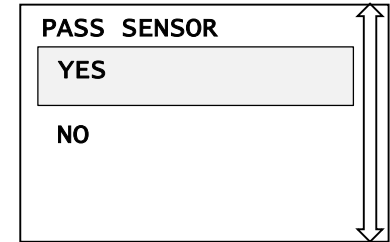

Press **UP&DOWN** buttons and change to the next **sub-MENU** option or press **RUN(X)** button to store the changes and thus return to the normal operating mode.

4.1.13 ALARM TONE DURATION SELECT
 (*only for ThruScan sX/ sX-WP /s15-i/sX-i)

You may adjust the alarm tone period. This period can be between 00 to 20 units. When the value is increased the alarm duration decreases.

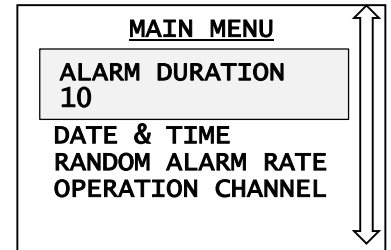

To adjust this period;

- 1- Press **UP&DOWN** buttons to find "ALARM DURATION" sub-MENU,
- 2- Enter to MENU by **SEL(√)** buton,
- 3- Select your alternatif by **UP&DOWN** butons,
- 4- Return to MENU by pressing **RUN(X)**.

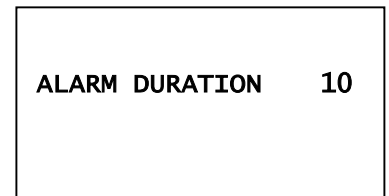

Press **UP&DOWN** buttons and change to the next **sub-MENU** option or press **RUN(X)** button to store the changes and thus return to the normal operating mode.

4.1.14 RUN TIME
 (*ThruScan sX, s15-i/sX-i, sX-WP)

This menu is to display the operation duration of ThruScan . Menu becomes active when the WTMD is turned on and by entering the menu Operation Duration can be checked. When ThruScan is Turned Off, the Duration Counter is reset to Zero and becomes active when turned on again.

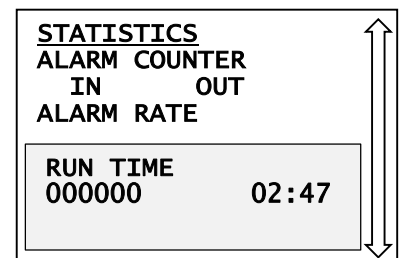

- 1- Press **UP&DOWN** buttons to find

- 2- Enter Menu by **SEL(√)** button,
- 3- Use **UP&DOWN** buttons for Selection
- 4- Press **RUN(X)** button to return to normal operating mode.

4.1.15 RANDOM ALARM RATE SELECTION
*(*ThruScan s15-i/sX-i only)*

With Adjustable Random Alarm Rate feature you can set your WTMD to Give Alarm with a Different Alarm Tone for persons who do not carry metal on. Random Alarm Rate can be set between %0 and %100.

1. Press **UP&DOWN** buttons to find **"RANDOM ALARM RATE"** menu.
2. Press **SEL(√)** button to enter menu.
3. Use **UP&DOWN** buttons for Selecting the Random Alarm Rate
4. Press **SEL(√)** button to save your settings.

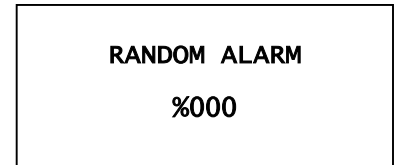
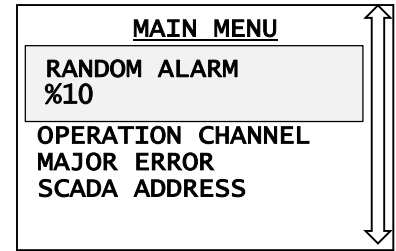

Press **UP&DOWN** buttons and change to the next **sub-MENU** option or press **RUN(X)** button to store the changes and thus return to the normal operating mode.

4.1.16 ALARM RATE
*(*ThruScan sX, s15-i/sX-i, sX-WP)*

This menu is to Display the Percentage of Alarms generated by *ThruScan*. Percentage of Alarms is the ratio of Alarms and Persons Passing through the WTMD. (Alarm Rate = Persons Pass Through WTMD /Alarms Generated).

1. Press **UP&DOWN** buttons to find **"ALARM RATE"** menu.
2. Press **SEL(√)** button to enter menu.
3. Use **UP&DOWN** Buttons for **Y** (reset), **N** (do not reset) selections;
4. Press **SEL(√)** button to save your settings.

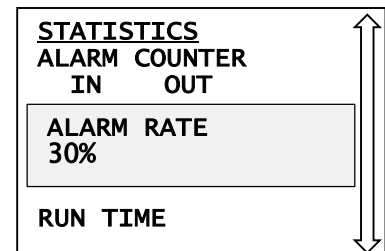

Press **UP&DOWN** buttons and change to the next **sub-MENU** option or press **RUN(X)** button to return to normal operating mode.

4.1.17 SELECTING OPERATION CHANNELS

This menu is to select the Operation Frequency of your WTMD. The operation frequencies have to be different when two or more WTMD's are in operation close to each other or when the electromagnetic noise conditions make it necessary.

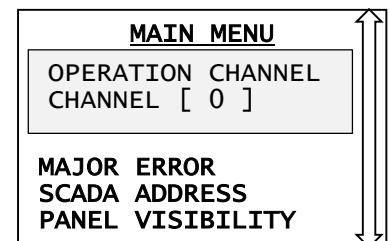

1. Press **UP&DOWN** buttons to find **"OPERATION CHANNELS"** menu.
2. Press **SEL(√)** button to Enter menu.
3. Use **UP&DOWN** Buttons to select the Operation Channel.
4. Press **SEL(√)** button to save your settings.

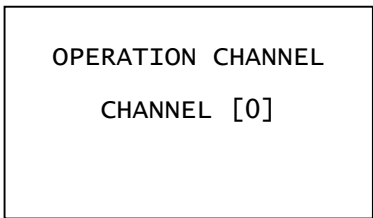

Press **UP&DOWN** buttons and change to the next **sub-MENU** option or press **RUN(X)** button to store the changes and thus return to the normal operating mode.

4.1.18 DATE & TIME SETTINGS

This menu is used for *ThruScan's* date and time settings

1. Use **UP&DOWN** buttons to find **"Date & Time"** menu.
2. Press **SEL(√)** button to Enter the menu
3. Press **SEL(√)** button to select the field required, use buttons **UP&DOWN** to make alterations
4. Repeat the above for each value required

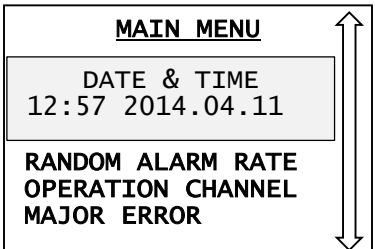

Press **UP&DOWN** buttons and change to the next **sub-MENU** option or press **RUN(X)** button to store the changes and thus return to the normal operating mode.

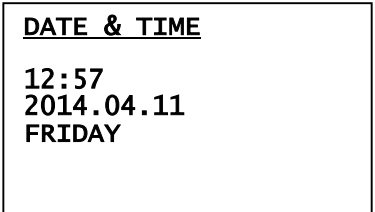

4.1.19 MAJOR FAULT

(Only *ThruScan sX-i*)

ThruScan continuously tests its operation and functions and displays the error when an unexpected condition occurs. For example, "ERROR 00" is displayed on the screen when the IR sensors do not see each other for a long time period. When an error is detected if the WTMD is required to alert the user with light and vocal signals then stop operating, option "YES" has to be selected in the menu. If "NO" is selected, the WTMD displays the unexpected error detected on the screen and continues operating.

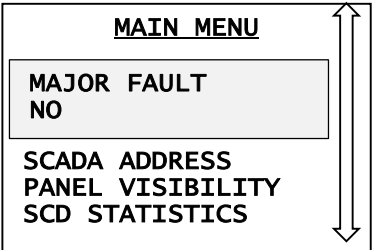

1. Use **UP&DOWN** buttons to find **"MAJOR ERROR"** menu.
2. Press **SEL(√)** button to Enter the menu
3. Use buttons **UP&DOWN** to make a selection
4. To save the setting press button **SEL(√)**

Press **UP&DOWN** buttons and change to the next **sub-MENU** option or press **RUN(X)** button to store the changes and thus return to the normal operating mode.

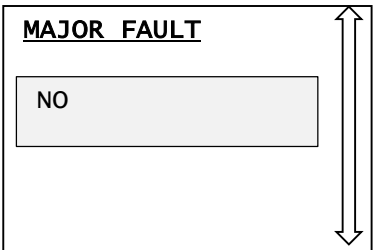

4.1.20 SCADA ADDRESS

(Only *ThruScan sX-i*)

When *ThruScan* is controlled via a connected PC, this feature is used to designate an address to the WTMD.

1. Use **UP&DOWN** buttons to find "**SCADA ADDRESS**" menu.
2. Press **SEL(✓)** button to Enter the menu
3. Use buttons **UP&DOWN** to assign a value
4. To save the setting press button **SEL(✓)**

Press **UP&DOWN** buttons and change to the next **sub**-MENU option or press **RUN(X)** button to store the changes and thus return to the normal operating mode.

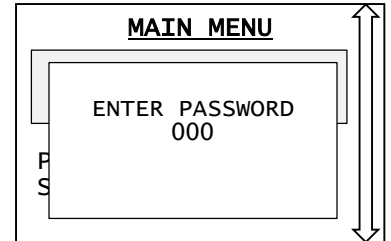
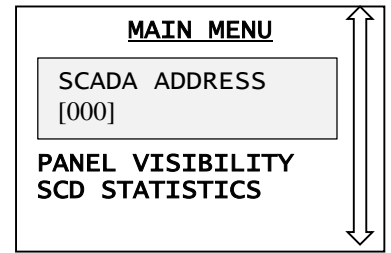

4.1.21 PANEL VISIBILITY

(Only *ThruScan sX-i*)

This menu allows the warning lights during an alarm to be active or inactive (see Section 3.4 Zone Indicating Lights) on the panels.

1. Use **UP&DOWN** buttons to find "**PANEL VISIBILITY**" menu.
2. Press **SEL(✓)** button to Enter the menu
3. Use buttons **UP&DOWN** to make a selection
4. To save the setting press button **SEL(✓)**

Press **UP&DOWN** buttons and change to the next **sub**-MENU option or press **RUN(X)** button to store the changes and thus return to the normal operating mode.

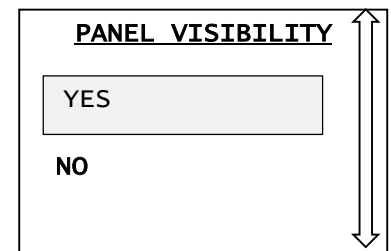
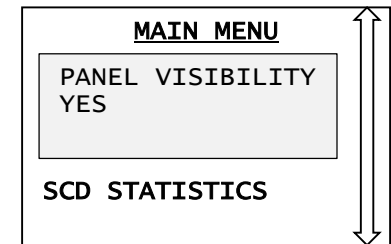

4.1.22 SCD STATISTICS

(Only *ThruScan sX-i*)

This *ThruScan* menu is used to view recorded alarms date, time, security value settings and alarm values information. The records can be viewed but cannot be altered.

5. Use **UP&DOWN** buttons to find "**SCD STATISTICS**" menu.
6. Press **SEL(✓)** button to Enter the menu
7. Use buttons **UP&DOWN** to check records
8. To exit press button **RUN(X)**

Press **UP&DOWN** buttons and change to the next **sub**-MENU option or press **RUN(X)** button to store the changes and thus return to the normal operating mode

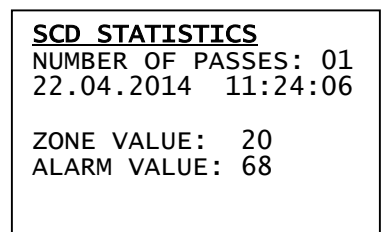
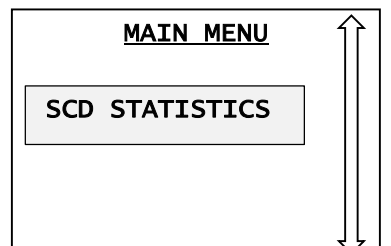

4.1.23 STATISTICS MENU

This menu is used for viewing recorded statistics information and for resetting this to zero when needed.

STATISTICS	
ALARM COUNTER	00012
00078	
IN	OUT
ALARM RATE	
RUN TIME	

5. SYSTEM OPERATION



ThruScan is easy to operate however; the unit must be used in a proper way to ensure correct detection & screening.

The operator (Security Guard-the person responsible for *ThruScan*) must follow the supervisor's instructions regarding the use of **WTMD** with necessary response to the alarms.

The operator's continuous responsibility is to ensure that *ThruScan* always operates according to the information displayed on the LCD and thus to determine the cause of any alarms.

The operator should ensure that the:

- *ThruScan* is always operating as required,
- Program and sensitivity settings are correctly made,
- LED VU display shows minimal interference (environment electromagnetic noise),
- Pacing is performed when Green (READY) pacing lights are on,
- Operation is realized according to the instructions.

5.1 NORMAL OPERATING MODE

As stated below operating and using *ThruScan* is easy.

Using the MENU, as stated in Section 4 it is very easy for the user;

1. Turn your *ThruScan* on by pressing the **ON-OFF** button from the Control Panel ensure that it has been properly programmed and set up as in section 4 above,
2. Carry out routine functional test (see Section 5.2),
3. If the daily traffic count is to be reset follow 4.1.6 above,
4. Ensure persons only enter the gate way when the green pacing lights are illuminated,
5. Finally if an alarm is generated refer to section 5.3 below.

5.2 ROUTINE TESTS

ThruScan should be tested daily before use and in addition at any time the unit is moved or against to the environmental changes.

The actual tests undertaken should be carried out to suit the operational requirements of the user, an example is as follows;

1. Switch on **ThruScan** (Press ON-OFF Button),
2. Check the correct Security Level is selected for the required operational risk (see section 4.1.1),
3. A 'clean tester' i.e. a person who has no metal objects on, should walk through the gateway to ensure that no alarm condition is activated. This procedure should be repeated at least 3 times at varying speeds ranging from 0.5 mt/sec. to approximately 1.5 mt/sec.,
4. The 'clean tester' should then carry out a series of tests by passing through the gateway carrying a sample or similar of a target or forbidden item to ensure the item is detected and the correct alarm condition is generated. This procedure should be repeated several times with the target item held at different locations on the body e.g. high, middle, low, left, right & centre etc. On each occasion the target item should be detected and the location indicated upon both the Graphic Display Panel (see section 3.1.2) and with the Zone-Lights on side panels, (see section 3.4),
5. The test in 4 above should be repeated with differing size target items as appropriate to the operational requirements and at varying speeds as above,
6. Should a target item fail to be detected check the Sensitivity Level is correctly set for that size of object,
7. Any failure or malfunction should be investigated immediately,
8. Once tests have been completed the Alarm Counter (see section 4.1.5) and the Traffic Counter (see section 4.1.6) may be reset ready for the day's operation.

5.3 ALARM STATE

If a person triggers an alarm when passing through the archway, the operator should instruct the individual to step outside the walk-through and remove any metal objects from their body and/or clothing. The operator should then either scan the person with a hand-held metal detector (**ThruScan** dx/dx-x), or ask the person to re-enter the WTMD.

If an alarm sounds after the person re-entering the walk-through, he/she must be rescanned with a hand-held metal detector-HHMD and the cause of activation should be determined. One should also remember a metal possibility by prosthesis organs.. i.e. pacemakers, etc.

The zone lights facilitate the screening process by indicating the location of all causes of alarm activation within 9 zone areas. In cases where there is more than one object, the lights appear in each array that requires investigation. This enables the operator to know from which area(s) objects require removal and to concentrate on the problem areas when hand scanning, resulting in improved overall security and increased transition.

If the operator finds a weapon or another forbidden object, he or she should follow the in-house screening procedures and the supervisor's instructions regarding the appropriate response.

NOTE: Remember that the cause of every alarm MUST be determined. If in doubt the operator should consult their authorized personnel or manager.

6 TECHNICAL SPECIFICATIONS

6.1 ELECTRONICS

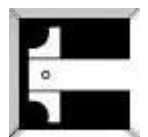

Digital-controlled, pulse induction, multi-zone metal detector; target location is discernible on the left and right sides of the body, from head to toe in 9 distinct zones. (Both the detection and

control circuitries comprise microprocessors.) Modular-designed electronics facilitate mounting and maintenance easily.

6.2 DETECTION FIELD

ThruScan's multi-zone detection field provides and completes horizontal and vertical uniformity. The sensitivity of each field can be adjusted to meet the requirements of specific security applications (****only for sX/ sX-WP /s15-i/sX-i***). *ThruScan's* unique design enables the operator to identify targets within 9 zones. Detection is precise, regardless of a target's location or orientation within the archway.

6.3 LANGUAGE

English & German & Turkish & Spanish is standard. (other languages optional)

6.4 SELF-TEST

As soon as your *ThruScan* is turned on, a self-test routine occurs for about 10 seconds during which time the warning buzzer will sound to warn that the unit is not yet ready for use. Should a fault in the system be detected a fault code will be displayed upon the LCD display.

Failure Codes are as follows:

- Error 00: The walk through infrared detector is blocked or failed.
- Error 01: Left Top Zone - High Metal Detection for a prolonged period.
- Error 03: Right Top Zone - High Metal Detection for a prolonged period.
- Error 04: Left Centre Zone - High Metal Detection for a prolonged period.
- Error 06: Right Centre Zone - High Metal Detection for a prolonged period.
- Error 07: Left Bottom Zone - High Metal Detection for a prolonged period.
- Error 09: Right Bottom Zone - High Metal Detection for a prolonged period.
- Error 11: Left Top Zone - No Detection for a prolonged period.
- Error 13: Right Top Zone - No Detection for a prolonged period.
- Error 14: Left Centre Zone - No Detection for a prolonged period.
- Error 16: Right Centre Zone - No Detection for a prolonged period.
- Error 17: Left Bottom Zone - No Detection for a prolonged period.
- Error 19: Right Bottom Zone - No Detection for a prolonged period.

(*for s3 only 6 error codes i.e.; 00, 06(right panel), 07(left panel), 16(right panel), 17(left panel), 26 is existing)

NOTE: 1) ThruScan also continually monitors itself during normal use. Should any of the above conditions be detected the fault code will be displayed. If no cause is ascertained pls. contact to the supplier, service company or factory.

2) WTMD, ThruScan may display a failure code(error 19) if not used or screened for a long time. In such case try and screen your WTMD with an unclean object with metal. If error message continue pls. contact your service company or supplier. Thus be sure that detection is performed in all areas.

6.5 SENSITIVITY

ThruScan has 246 sensitivity settings available for each security level(channel) providing a high degree of detection accuracy. Sensitivity is used to calibrate the detector to detect precise quantity of metal for any defined object.

NOTE: ThruScan is a highly advanced and reliable security metal detector. However, its success ultimately depends on the training and diligence of the person who operate it and the overall security plan of which it is a part.

6.6 MEMORY

An electrically erasable non-volatile memory stores all of the program settings whether power is on or off. Erasing the information stored in the memory is only possible through some procedures carried out by the user.

6.7 TRAFFIC COUNTER

A built-in and erasable traffic counter counts transitions through WTMD; Incoming & outgoing traffic counts are independently displayed on LCD display. This specification may be hidden when requested (See 4.1.9).

(*pls. note ThruScan s3/s6 has only one direction counting!)

6.8 TAMPER PROOF

The access to control panel is double secured by a mechanical lock. And thus it protects the access to the system controls. Changes to the 'set-up' program MENUs are further protected by a 4-digit PIN CODE (changeable).

(* for ThruScan s3/s6 mechanical lock is optional but the protection by 4 digit pin-code is the same.)

6.9 REGULATORY INFORMATION

ThruScan s meets NILECJ L/1-3 standards.

ThruScan s meets VDE 871 Noise Value.

ThruScan s3/s6 meets IP 20,

ThruScan s9 meets IP 44,

ThruScan sX/s15-i meets IP 44, can be produced suitable for IP65

ThruScan sX-i/sX-WP meets IP65, Outside Area WTMD, in conformance with IP65 - IEC, CEI 529 standards.

ThruScan is produced using materials meeting TSE and/or TSEK norms.

ThruScan is within the magnetic emission limits approved by FDA (American Food & Drug Administration). It is certified by officials that *ThruScan* has no effects on people using pace-maker, the pregnant women and any magnetic media. A "Certificate of Expertise" report on this subject is issued and presented in Appendix-10.1.

6.10 INFRARED PASS SENSORS

The performance of *ThruScan* is enhanced by twin/stereo infrared sensors mounted in the side panels that:

- Minimise the effects of noise and other external influences by limiting the detection capabilities to only those individuals and objects that are passing through the WTMD,

- Greatly reduces the occurrence of false alarms by inhibiting alarm activity without a person in the archway. In circumstances where large metal objects, such as luggage or supply carts and x-ray equipment, pass by or are located near the unit, the sensor automatically inhibits the alarm,
 - Generates a traffic count of the number of persons passing through the detector in both directions.

(*for ThruScan s3/s6 this feature is achieved by a mono sensor under the Control Unit thus counting in one direction!)

6.11 ELECTROMAGNETIC NOISE & INTERFERENCE REJECTION/DIRECTIVES

ThruScan has integrated high quality/high-tech filter circuitry, which substantially eliminates and rejects spurious magnetic and electrical interference under norms (89/336/EEC) for itself and mains. As a result of the tests carried Conformity to CE directives, EU European Union Directives for Safety; EN 60950; Electromagnetic Conformity EN 61000-6-3(emission), EN61000-6-1(immunity) has been approved.

6.12 MASKING

ThruScan incorporates special anti-masking programming which guards against dissimilar metal objects cancelling one another and evading detection. This way false alarms or state of no alarms are minimised. *ThruScan* sounds an alarm for every area where a metal exists.

6.13 SYNCHRONISATION

If two or more *ThruScan* units need to be placed next to one another in tandem (multiple operation) Operation Channel of the units can be changed for interference free operation. There are 4 different operation channels available with every *ThruScan* WTMDs as a Standard Feature. Synchronization can also be done by using the Synchronization Cable. For this the Synchronization Cable (optional) must be used.

If the cable connection is maintained, one of the WTMD operates as **the main (master) unit** and the other as **the slave (satellite)**.

For the synchronization of the units:

- 1- Attach the connection cable to the sockets with the  sticker on the side panels.
- 2- Choose the main and slave unit
- 3- Open the back cover of the control panel of the slave
- 4- Turn OFF the switch on the main card on the control panel of the slave
- 5- Close the back cover of the control panel of slave.

The WTMDs will operate by pressing the ON button after these steps have been taken.

NOTE: When the main WTMD is OFF the slave can not operate

NOTE: If the WTMDs will be used separately again then plug out the synchronisation cable (phone cable connections-RJ 11/12) from the side panels. Then switch the key of the slave unit from OFF to ON position.

NOTE: During synchronisation procedures, the WTMDs' should be Shut OFF.

6.14 ELECTRICAL REQUIREMENTS

Operating voltage: 70 – 270 VAC (supply should be well grounded/earthed and the ground must be in proper electrical norms) - 50/60 Hz.

*External SMPS (Input:100-240 vac, 50/60Hz, 1.0 A Output: 15 vdc, 2.66 A)
(*only *ThruScan* sX WP)

Power consumption: 10 Watts in standby mode
20 Watts in alarm mode (max)

6.15 CONSUMPTION EFFICIENCY

As described in article nr. 6.14 above, electrical values can be found. WTMDs are being produced to operate 7/24.

However, for energy saving the WTMD is recommended to be in Stand By mode when there are no passers by.

6.16 OPERATING TEMPERATURES

(-4° F) -20° C to +(158° F) +70° C

6.17 HUMIDITY

Up to 95% non-condensing.

6.18 THROUGHPUT/TRAFFIC RATE

High speed detection circuitry enable a high transition of approximately 50~60 persons per minute (may vary with the metal magnitude) depending on the alarm activation delay.

(for s3/s6 30~40 persons/min)*

6.19 WEIGHT (~ kgs.)

ThruScan s3/s6/s9

Main control & display unit : 7.9
Back fixing crosspiece : 2.8
Each side panel : 16
Fixing apparatus : 3.6
Assembled weight : 45.6
Packaged weight : 65

ThruScan sX/s15-i/sX-i

Main control & display unit : 7.9
Back fixing crosspiece : 2.8
Each side panel : 19
Fixing apparatus : 3.6
Assembled weight : 52.3
Packaged weights : 70

ThruScan sX-WP: 75 Kgs (3 Boxes)

6.20 WARRANTY PERIOD

24 months. (See Section 10.3) By the ministry a 10 years life span has been allocated.

6.21 DIMENSIONS*

	<i>ThruScan s3/s6</i>		<i>ThruScan s9/sX/sX-WP/s15-i</i>	
	Interior(mm.)	Exterior(mm.)	Interior(mm.)	Exterior(mm.)
Width	740	850	740	850
Height	2000	2200	2000	2200
Depth	520	520	580	580

	<i>ThruScan sX-i</i>	
	Interior(mm.)	Exterior(mm.)
Width	740	900
Height	2000	2200
Depth	580	580

*These dimensions have an approximation of +/- 10mms.

Packing dimensions, Side Panels: *ThruScan sX/sXWP/s15i* için 620x2265x230 mm

NOTE: The place where the WTMD will be fixed should have an extra 50 cms. extra space than the unit's exterior measurements. Dimensions on sX-WP have to be with tolerance of 30 mm and a project has to be prepared if the fixation will be at the top of the unit.

7 OPTIONS



7.1 SRC-SCADA REMOTE CONTROL PACKAGE

SRC-SCADA Remote Control Package is prepared for the communication and the data transmission between your computer/PC and your Magnetic Walk Through Metal Detector, *ThruScan*.

With the SRC-SCADA Remote Control Package you may do all of the adjustments, present in your WTMD *ThruScan*'s MENU, including Security Level & General Sensitivity, Zone Sensitivity, and the Counters.

You may analyse the information displayed in your *ThruScan* and you may send the adjustments you have made using your computer to your WTMD *ThruScan* via standard telephone connection or direct cable connection or by satellite/thuraya.

The equipments included in this package are as follows:

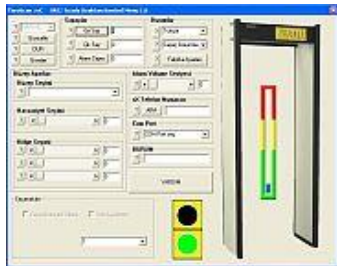

- SRC-SCADA Remote Control Software (separate softwares are used for *ThruScan sX/sX-WP/s15-i/sX-i* and *ThruScan s3/s6/s9*)
- Specially modified Modem and Special Connection Cable

Up to 99 *ThruScan sX/sX-WP/s15-i/sX-i* units can be controlled using the same cable with this type of connection. The hardware necessary for this remote control is contained as a standard feature (hardware) in your unit. For installation and operation details, see the SRC-SCADA Remote Control Software Manual in Section 10.2 and mounting questions in section 9.2

ThruScan s3/s6/s9 models are capable to control up to 16 WTMD units by one PC and cable.

IMPORTANT NOTICE: With SRC-SCADA program it is possible to shut off all the visible displays, lights of the equipment! So this feature enable ThruScans to operate as idle and thus to detect from a remote location but without any indication of screening, SECRETLY!...(optional)

7.1.1 SRC-SCADA REMOTE CONTROL SOFTWARE

You may control all of your *ThruScan* (s3/s6/s9 for up to 16 units) *ThruScan* (sX/sX-WP/s15-i/sX-i for up to 99 units) utilized for security search from the security observatory room, using this program specially designed for places where integrated security measures are necessary, such as airports, shopping centres, military premises, jailhouses, public environments, control points of excess threat, etc..

All settings can be done remotely using this software. Real time WTMD's can be screened. Recordings can be made on a hard disk. Usage with an optional kiosk is possible. Face image photos can be taken and saved with date and time information.

Program is available in English, German, Turkish and Spanish languages and should be used under Windows Operating System (*).

(*) with the courtesy of Messrs., Microsoft Inc.



The program can be installed from the factory's web site (www.elektral.com.tr) or the CD given with the WTMD as an option. User's password is required for the activation through mail or telephone from the factory or the dealer.

See Section 10.2 for the Manual of this Software.

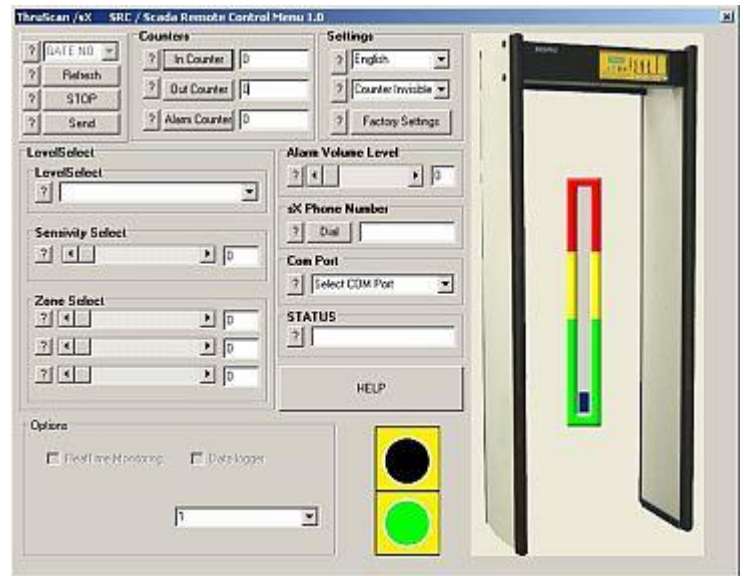

ThruScan s3/s6/s9 SRC-SCADA Software

Software **ThruScan** sX/sX-WP/s15-i/sX-i SRC-SCADA Software

7.1.2 REMOTE CONTROL (by MODEM)

The second accessory of the Remote Control Package is a specially modified modem. This modem is not a standard modem. It decodes the data communication from your **ThruScan** via phone line into a format in order to monitor by your PC. It is only necessary for connections by the phone lines. The modem cable to the WTMD should not exceed 10 mts.



7.1.3 REMOTE CONTROL (by CABLE)

Remote Control can be performed without modem by cable (max 100 mts.). For the places where there is a control observatory room within the area to be controlled. Such as airports, shopping centres, military premises or jailhouses or military control points, etc. If more than one WTMD will be observed from one PC than please inform your dealer in advance for the specific cable and the necessary technical support to get the video from REAL-TIME VISUAL PROSECUTION UNIT to TV.

7.2 OUTDOOR PACKAGE

For outdoor weather-proof execution please prefer, *ThruScan* sX-WP. You may buy outdoor package to use *ThruScan* s3/s6/s9/sX/s15-i/sX-i outdoors temporarily.

7.2.1 RAIN PROTECT SHELTER/HAT

In cases where *ThruScan* should be used outdoor, a peculiar "Rain Shelter/Hat" is provided. This shelter is designed to protect your WTMD from direct rain. Your unit must not be left outside and it must be placed back indoors once its outdoor duty is completed. If the unit is to be operated outside permanently, then it should be preferred to be kept in a cabin to protect it from direct sun rays, wind, and water.



NOTE: WTMD is versatile electronic equipment. Normally, it must be used indoors to provide a means of protection. Pls. remember protection class.

NOTE: The main supply cable for your WTMD must be insulated to prevent any short circuit and connected to your WTMD through the appropriate window on the rain shelter.

NOTE: Once the cable is passed through a hole on the rain shelter after the drilling, isolation has to be made on that hole to prevent leakage of water.

NOTE: The drain hole is placed on one side of the rain shelter and it is symmetrical from left to right. Thus the shelter should be converted from left to right depending if any electronic connection is under this drainage hole or if there is another detector operating in synchronisation next to it.

7.2.2 SIDE PANEL PROTECTION COVER

The "protection cover" is designed to protect the side panels from drizzled rain. It is made of plastic material.

7.3 BATTERY GROUP

ThruScan operates for approximately 2 hours with its standard inbuilt uninterrupted power supply/UPS with batteries. It is possible to increase this duration upon demand optionally.

7.4 WTMD WHEELER

This device is designed as an accessory for the WTMD *ThruScan* models to ease their transportation. (See 10.4)



7.5 CARRIAGE BAG

Carriage Bag is an option to provide an easy transportation where WTMD Wheeler can not be used for an unassembled WTMD. (i.e. for ships to be unpacked for assembling in ports for the security of the passengers)

7.6 IRDA REMOTE CONTROL (*only for *ThruScan sX/s15-i/sX-i*)

This unit enables to operate and manipulate WTMD in an adequate distance by IRDA technology. Security personnel can control the unit from a distance behind a bullet-proof cabin under threat. (see 10.3)



7.7 REAL-TIME VISUAL PROSECUTION UNIT

This unit can be assembled on *ThruScan Walk-Through Metal Detectors (WTMD)* as an optional external part. The Passage and around the WTMD can be continuously observed using a TV. Alarmed Visitors and/or movements around the WTMD can be captured by Real-Time Visual Prosecution Unit. Captured images are saved to an SD Card. (there is an SD card Slot on the upper part of the control unit keypad)

Assembly and Operation guideline of the Real-Time Video Prosecution Unit is as follows;

Remove the Screw and Nut from the Camera installation bar. First insert the Camera Cable and the assembly bar from the hole on the control unit. The bar is designed to fit into the fixing piece inside the control unit. Use the Screw and the Nut to fix the Camera Assembly bar to the Control Unit. Connect the camera socket to the same number connector inside the control unit.

If you wish to continuously observe images from the system using your TV, use the cable delivered along with the Real-Time Video Prosecution Unit. The RJ11/12 socket should be connected to "TV" Marked Connector on the Control Unit and connect the other end to your TV.

Settings are done by using the Remote Control Unit. To enter Programming Mode enter [8888] access code. This Code is Standard and can not be changed. After entering the code, 'CAMERA MENU' will be displayed on LCD and you may proceed the below settings.

WARNING: If 'Remote Control' warning is displayed on LCD when entered the code, then the PIN code of the *ThruScan* is set to [8888]. The PIN Code must be changed.



RJ11/12 Connector to observe images from REAL-TIME VISUAL PROSECUTION UNIT:

Connection is, as follows from left to right;

1.RJ 11/12 Socket

1. EMPTY

2. VIDEO

3. EMPTY

4. EMPTY

5. GND

6. EMPTY

General Characteristics

Video Output : NTSC/PAL TV Out

Image : JPEG 800x600

Video : AVI 5fps 320x240

Image Size : ~80KB (HQ) ~40KB(SQ) (depends on image)

Video Size : ~600KB MPEG, QVGA (320x240), 5fps

Multicapture : 10 images per shot

- Capturing** : Capturing with motion detect or alarm.
- Memory Size** : Max. 2GB SD Card supported. Unless SD Card is not on it. it can store in its memory for a few images. Maximum 1024 folders and for each folder 1024 images can be stored.





Operation

ThruScan Users can make his own keyboard according to the key definition stated and perform the following operation.

1 Change mode between view and play back

By default, the DVR is in view mode and show channel 1 when power is on. One can press  to switch view or playback photo screen

2 Change viewing channel and PIP

- 2.1 Press  to change view from Ch1 to Ch2
- 2.2 Press again  and view PIP, Ch2 in Ch1
- 2.3 Press again  and view PIP, Ch1 in Ch2
- 2.4 Press again  to cycle from viewing Ch1

3 Capture photo



- 3.1 Use external trigger to capture: refer to section 4, as below.
- 3.2 Manually: at View mode, press  to snap an image
- 3.3 By motion detect: pls refer to the following setup section, once it is in armed mode, the DVR will capture the image when motion detected.
- 3.4 Use short cut key (CH +) to arm the system at View mode

4 External trigger for capture

- 4.1 Activation depends on which camera is active.
- 4.2 If ch1 is in view, if TG1 active, capture a photo from ch1, if TG2 active, the system will switch to ch2 and take a photo from ch2 then keep the ch2 in view, until manual change to ch1.
- 4.3 If both channels have been triggered at the same time, the first triggered channel will be valid.

5 Playback the photo inside the memory

The captured photos will be stored in different folders for easy searching. The folders are named according to the date sequence. If there is no file in the memory, it will show "NO FILE" and enter view mode.

- 5.1 press  button to enter playback mode
- 5.2 press (OK) to enter thumbnail view, press again (OK) to normal view
- 5.3 use (V - / V +) button to forward or rewind the image
- 5.4 press (CH +) to turn on off the OSD
- 5.5 press  to show folder name, use (CH + / CH -) key to scroll, OK to select

6 Delete files from memory

- 6.1 At playback mode, press  to enter playback menu, by using (V - / V +)key, one can select delete current image or all files in the current folder. Press OK to confirm and reconfirm by selecting a tick icon.
 - 6.2 One can select format to delete all files in all folders
- Delete Menu



7 System Setup

At preview mode, press 

Set Up Screen

7.1 Set up Date time

7.1.1 Use (V -/V +)key to select date or time and (CH +/ CH -) key to set the correct digit. The setting will then store into system. Press (OK) to confirm.

7.2 Set up auto capture – enable or disable

7.2.1 Press (OK) to toggle enable or disable

7.3 Set up the capture format – AVI or Photo

7.3.1 Press (OK) to toggle AVI or Photo, press (V -/V +) key to select next.

7.4 Advance Setup

7.4.1 Set up the auto return preview. When there is a long idle time at non-preview mode, user can select to enforce system to enter preview mode Press (OK) to toggle not return or auto return preview in 10 or 30 second

7.4.2 Set up the image quality: Press (OK) to toggle HQ or SQ(default is HQ)

7.4.3 Set up motion detect count: default is 1, press (OK) to select from 1 to 10, this means the number of images will be captured at every trigger. Use (V -/V +) move to other item

7.4.4 Set up motion detect interval: default is 1, press (OK) to select from 1to 9, the bigger figure the longer interval to active the detection. Setting n is about n+2 sec between 2 snap shot.

7.4.5 Set up motion detect sensitivity, use (OK) to select Hi, Mid, Lo, default is Hi
2 rev 1.0

7.4.6 Set up frame rate setting, use (OK) to select 1, 2, 5, 10,15fps

7.4.7 Set up recording duration, press (CH +/ CH -) to select 5, 10, 20, 30sec

Remark: This recording duration is only applied to the auto capture. At manual capture mode, if frame rate is set to 1 or 2fps, there is no limit of capture duration until memory is full. But when frame rate is set to 5, 10 or15fps, the max duration is limited to 30sec. This will keep the system more stable.



Set Up Screen







NOTE: Default is full screen MD about Motion detect area.

7.8 Alarm Output

If the active channel has a motion detected, it will output an active low signal to Alarm Out, user can connect it to trigger external device such as siren. Note, this feature is only active at motion detect on and only main viewing channel in PIP mode.

Icons and Definitions

Set up Menu

	Date Time setup		Advance Set up
	Motion Detect On or Off		Quit Menu
	Select Photo or Video		

Advanced Settings

















	Return to preview mode		Select image quality Hi or Low
	Select image quality Hi or Low		Motion detect interval setting
	Motion detect sensitivity		AVI frame setting
	AVI duration setting		Quit

Photo Management

	Delete one photo		Format memory, clear all files
	Delete one photo		

REMOTE CONTROL BUTTONS

-  : Is used to exit from IR control menu. Or to go back to main menu in IR control menu.
- V + : RIGHT
- V - : LEFT
- CH + : UP
- CH - : DOWN
-  : MENU
-  : MODE
-  : SNAPSHOT
-  : CAMERA SELECTION
- OK : The button, which is in the middle of V + ve CH + buttons

7.9 NILECJ Test Kit

NILECJ Test Pieces Bag, American National Law Enforcement and Justice norms to test Walk-Through Metal Detectors. Consists of different size Metal Objects simulating Guns, Smaller Threat Objects to be detected and some Everyday use Metal Belongings considered not dangerous which the WTMDs should not Give alarm at Certain Sensitivity Levels.



7.10 LED Zone Indicators on Both Sides (Back/Front)

LED zone indicators at the back of the detector can also be put at the front face. In this case, a security guard can notice alarms from behind the device also. People waiting in screening queue can also see where the detected metals are on the person in the passage. Available with sX, s15-i and sX-WP models.

7.11 Object Sliding Table

Object Sliding Table is a Must Have product for professional Security Checkpoint Concealed Weapons Detection applications. It is made of rugged water resistant ABS material used for WTMDs and its special design sliding part on top provides ease of use and offers comfort for visitors.

Technical Specifications: Made of 4 mm ABS Plastic, approx 780 x 500 x 350 mm
80 mm sliding top depth

Available with all WTMD Models.



7.12 Queue Barrier

Chrome plated, 90 cm height, weights approx. 9 kg, 2.5 m length and 48 mm thick red ribbon with yellow ThruScan logo print. 76 mm Pole diameter with inbuilt automatic winding mechanism. Quadruple ribbon fixing joints enabling versatile usage. Steady stand with carved design flange.



7.13 Hand-Held Metal Detector

Hand-Held Metal Detectors are widely used before hands-on searching of alarmed visitors after Walk-Through Metal Detectors. Also the portable screening solution enables checkpoint procedures at places where there is no Walk-Through Metal Detector. For more detailed information please refer to products section. ThruScan dX and dX-X HHMDs operate at very low mA levels (Stand by: max. 5 mA, Alarm: max. 15 mA) enabling professional solutions with their high sensitivity and long operation hours.



7.14 ShoeScan Metal Detector

ShoeScan detects threats with audio-visual alarm indication reliably without the need to remove shoes. It has Very High Throughput Rate of 60 Person/Minute. ShoeScan Detects all Metals both ferrous and non-ferrous. ShoeScan has adjustable sensitivity feature. Built-In Battery Back-Up Feature against Electricity Cut Off.



8. MAINTENANCE & REPAIR



8.1. PERIODIC MAINTENANCE

Periodic maintenance requires that you inspect for loose or damaged parts and clean the surface of the *ThruScan*'s exterior. The following procedure is recommended;

1. Open the rear cover of the Control Unit and ensure that all connectors are snapped and screwed securely,
2. Inspect the windows of the "IR Pass Sensors" to ensure they are not obstructed,
3. Ensure that the eight bolts that attach the "Control Unit" and "Back Fixing Crosspiece" to the side panels are in place and tight,
4. Ensure that the archway sits flatly on the floor and does not sway or rock,
5. Ensure that the power cord and cable to remote WTMDs are in good condition. If defected replace immediately,
6. Clean exterior surfaces with damp cloth. Use only denatured alcohol for heavy-duty cleaning. Please remember that the plastic parts are made by ABS and the metallic parts are painted by electrostatic epoxy paint.

For *ThruScan sX-WP*, additional maintenance is required in the event of extreme weather conditions such as snow.

8.2. REPAIR

The modular design of *ThruScan* facilitates mounting, dismounting and maintenance. It is easy to follow procedures with its user-friendly MENU. If problems are detected, see section 9.1. General problems related with Mounting and Operating are explained here.

You may always get updated and detailed information from our web-site www.elektral.com.tr If problems are related with the environment, see Section 2.1 or contact your Dealer or our Company for assistance. Adjusting or relocating the or removing nearby objects or just checking the mains ground if it is properly done often solves the problem of WTMD failures.

If the equipment does not perform properly please do not hesitate to contact your dealer or our Company for any assistance.

8.3. MODULE REPLACEMENT

The system comprises a series of removable and replaceable modules that are tested and calibrated independently thereby eliminating the need for adjustments to the electronic mounting. However, after any component is replaced, the system must be tested thoroughly to confirm that *ThruScan* operates properly.

8.4. WARRANTY PROVISIONS

ELEKTRAL® A.S ("Elektral®") warrants conditionally that this *ThruScan* Metal Detector is protected by the following limited warranty (for components and labour) for a period of 24 months (pls. see our "Warranty Conditions"). During this 24-month period ELEKTRAL® will inspect and evaluate all security equipment returned to its authorised repair station or factory to determine if the equipment meets Elektral®'s performance specifications. Elektral® will repair or replace—at no charge to the owner—all parts determined faulty. Elektral® Elektromekanik Sanayi ve Ticaret Anonim Sirketi always hold the authorization to determine whether the failure is in accordance with her "Warranty Conditions" however our main motto is to satisfy and please our customers. All

parties agree that the final place of overhaul is the official premises of Elektral® in Izmir-Turkey-Ataturk Industrial Zone and the transport costs or the travel costs of technicians are not beard by Elektral® himself. (see Section 10.5)

This Warranty does not cover batteries nor any and all failures caused by abuse, tampering, theft, failure due to weather, battery acid or other contaminants and equipment repairs made by an unauthorized party.

This warranty is expressly in lieu of all other warranties, expressed or implied, including the warranty of merchantability or fitness for a particular purpose.

The Buyer acknowledges that any oral statements about the merchandise described in this contract made by Seller's representatives, if any such statements were made, do not constitute warranties, shall not be relied upon by the Buyer and are not a part of this contract for sale or delivery. The entire contract is embodied in this writing. This writing constitutes the final expression of the parties' agreement and is a complete and exclusive statement of the terms of this agreement.

The parties agree that the Buyer's sole and exclusive remedy against Seller shall be for the repair and replacement of defective parts. The Buyer agrees that no remedy (including, but not limited to, incidental or consequential damages for lost sales, lost profits, injury to person or property) shall be available to him.

Service Station:

Elektral Elektromekanik San. Ve Tic. A.S.
Izmir Ataturk Industrial Zone, M.K. Ataturk Blv. 23 Cigli
35620 Izmir -TURKEY
Phones: +90(0)232 376 7300 Fax : +90(0)232 376 7030
e-mail : elektral@elektral.com.tr

9 TROUBLESHOOTING



You may find the answers to your basic questions related with the mounting and operation of your WTMD in this section.

- 9.1 Frequently Asked Questions
- 9.2 Installation Problems
- 9.3 Operational Problems

9.1 FREQUENTLY ASKED QUESTIONS

**** Is technical personnel necessary for the mounting of the WTMD?***

Mounting and dismounting this WTMD is very easy. The user can easily set it up and use it. Following the instructions in the manual step by step the mounting can be performed. Its design prevents false mounting. The male and female connectors are matched individually. Therefore the risk of false connection is minimized.

****There is NOT a proper GROUND at the mains. What should I do?***

Never use your WTMD through mains without a proper ground. It is hazardous and not possible to operate WTMD in this circumstance with floating voltages.

**** May I or any technical personnel take care of problems occurring by our WTMD?***

If problems persist even after the completion of the instructions in the users manual and the section of solving problems, please contact out ASS-After Sale Services. Interference of unauthorized people may both cause worse problems with your WTMD and exclude it from the warranty.

****How many hours a day may I operate this WTMD?***

The WTMD is designed for continuous operation of 24 hours.

****How do I clean it?***

You may clean it with dry or damp clothing and/or with anti-static fluids for electronic equipment. Never clean using direct water or chemicals, detergents etc... See section 8.1

9.2 INSTALLATION PROBLEMS

****What kind of equipment do I need for mounting the WTMD?***

All tooling and accessories for the mounting are included. You can mount without any extra equipment except an electric stroked drill. See section 2.2

****May I fix it from the top or the sides to other utilities?***

This is an electronic equipment, so no procedures can be made such as cutting its panels or case or drilling it in order to stable or any other means. Otherwise warranty will be void. When necessary to fix your WTMD from the top or the sides, it would be best to fasten gently without harming it.

****Is it possible to use WTMD without fixing it to the ground?***

It is not advised to operate WTMD which will be confronted to constant hits and bumps, without fixing it to the ground. Serious bumps may cause it to fall down.

****Would relocating the WTMD cause any failure?***

Following the mounting and dismounting procedures in the user's manual would not cause any failure.

****Are there any restrictions for the place of the mounting?***

You should mount your WTMD as in the necessary distance, away from moving metal objects. This distance should at least be 1 meter depending on the type of the moving metal. Also the environmental conditions should match with the security class of your WTMD. See section 2.1

****Is it possible to have the mains input from Top to Bottom or Bottom to Top?***

The standard position of the mains input for *ThruScan* WTMDs is at the back cover of the control unit. If the desired location for the mains input on the WTMD is clarified prior to the order, the mains input may be arranged to be on the desired point if allowed.

**** How can I operate multi WTMDs together?***

To operate your WTMDs in parallel, you should follow the instructions in Section 6.13 If there is no specific provided cable then a twin cable should be connected from outputs 1 and 2 via the proper connectors between the sockets of the *ThruScan* s as shown in Section 3.7.

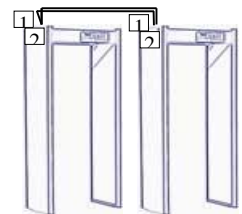

Do not forget to turn OFF the switch on the main board of the slave WTMD. See Section 6.13

**** I want to control my WTMD inside the building with the SRC-Remote Control SCADA Software. How should I arrange the connection?***

A special connection cable is provided by the producer along with the Remote Control SCADA Software. Plug in the appropriate end of this cable to the socket explained in Section 3.7 and the other end to the Communication Port of your computer (COM).

You may also use BUS Network or the Star Network as the Communication Technology.

An example is explained in the picture below. You may learn the details about the programming from Section 10.2. Also See Sections 3.7, 6.13, 10.2

BUS NETWORK
(S3/s9; 16 pcs – sX; 99 pcs)

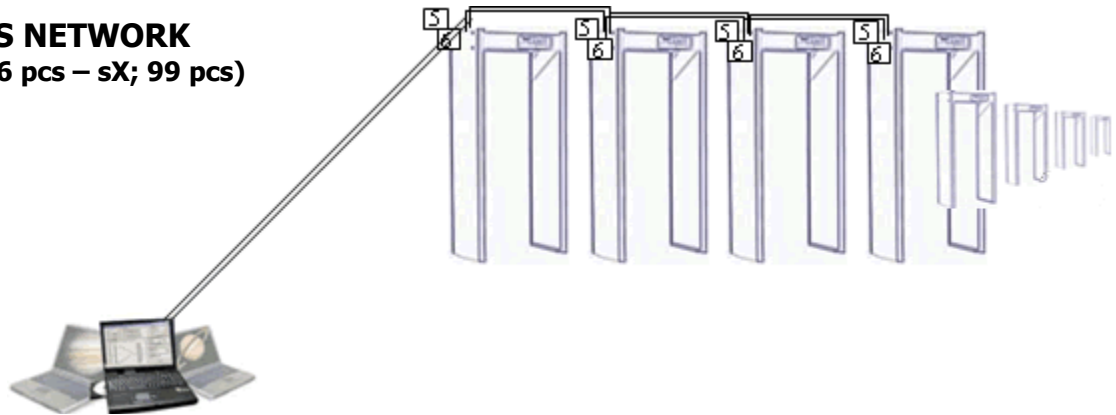

STAR NETWORK
(S3/s9; 16 pcs – sX; 99 pcs)

It is also possible to utilize separate cables for each *ThruScan*

*** I want to operate my WTMD through a standard telephone line using the Remote Control SRC-SCADA Software. How should I make the connection?**

You may operate and/or make the adjustments of your WTMD from anywhere around the world using

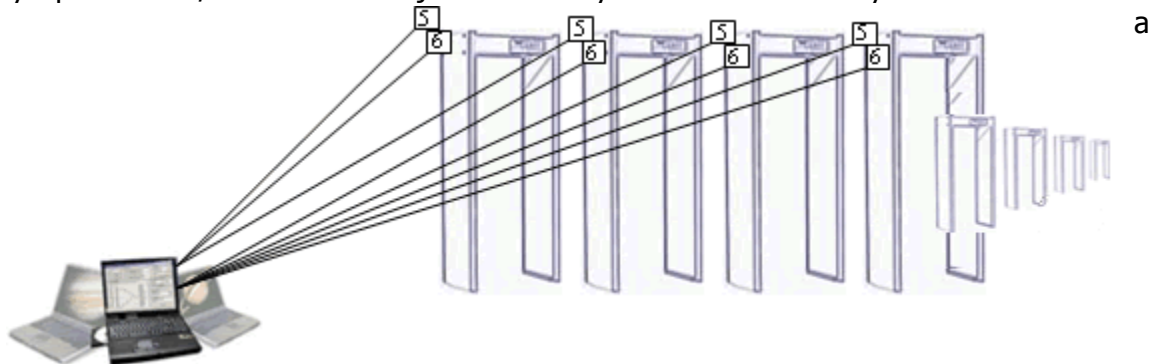

standard telephone line as cable or satellite connection (GSM or THURAYA). The accessory necessary for this process is a modified modem and a special connection cable prepared by the factory. One end of the connection cable consists of a 25 dSUB (See 7.1.2 for modem) and the other end is in the shape of a standard telephone connector (for *ThruScan* see 3.7).

If the control of more than one WTMDs would be made by means of this line than there should be a connection as shown below or each connection cable taken from the WTMD separately should be brought where the modem will be used.

It is explained in details in Section 10.2 how to make a connection between **SRC-SCADA** software and *ThruScan*.

For MODEM execution;

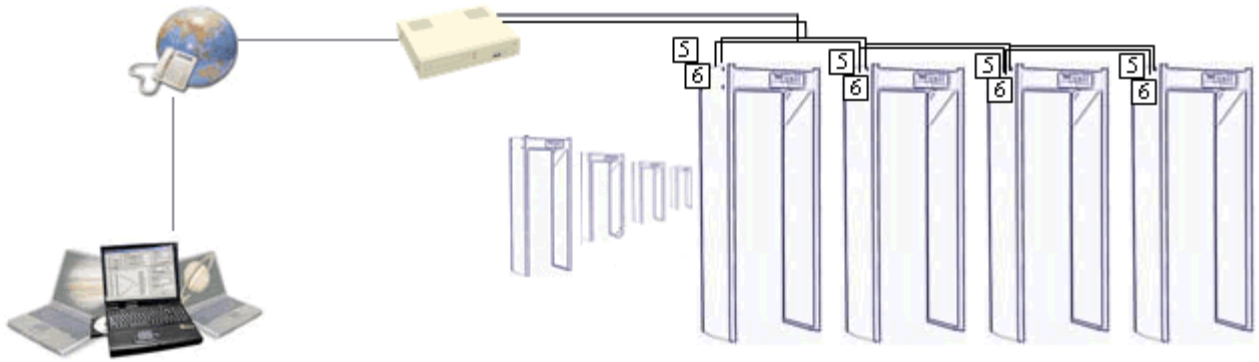

*** I want to synchronise my WTMDs and use the Remote Control SRC-SCADA Software at the same time. How should I make a connection?**

The same connector (SYNC/SRC SOCKET) socket is used for SRC-SCADA Remote Control and Synchronized operation.(See 3.7) The terminals/wires(5-6) should be used from the "synchronizing operation cable" and has to be connected to computer or the modem. This process should be performed by a technical staff. This cable is provided as an accessory.

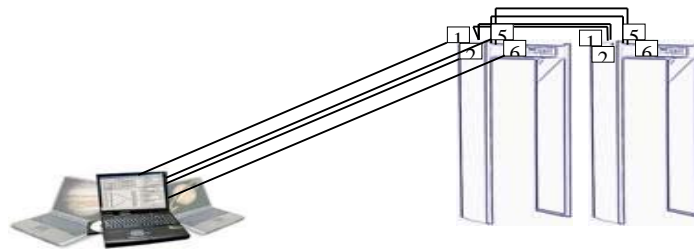

*** What is the maximum distance could be between my computer and ThruScan ?**

It depends on the Cu-quality/Thinnet of the cable. With the cable supplied by the factory, you may have a data communication up to 100 meters.

9.3 OPERATIONAL PROBLEMS

***Does keeping the WTMD without operating for a long time require any adjustment or maintenance?**

Storing in suitable conditions or keeping without operation does not cause any break downs or require new adjustments. However, failure may occur caused by rechargeable batteries. Because of this, the storage batteries have to be removed. See section 8.4

***How can I adjust the Sensitivity Level?**

It is explained in the manual how to adjust the sensitivity level. Do not forget that if you increase the sensitivity the level will approach the 0 value. See Section 4.1.1

***What is the recommended sensitivity level?**

The level as the factory default is normally the recommended sensitivity level. However, it is further advised that the sensitivity level should be adjusted by the user, according to the needs of the place. See 4.1.1 and 4.1.2

****How should I use the AD-Auto-Detection, sensitivity assignment MENU ?
(*for ThruScan sX series only)***

Please refer to user's manual. This MENU is designed in assigning a sensitivity level and states an approximate value. It is recommended that the Sensitivity should be further adjusted by the user, depending on experience, in cases of critical security. See 4.1.3

****Is it possible to operate the WTMD in places where there's no mains line?***

Your WTMD would continue its standard operation in a power failure for approx. 2 hours with its UPS. This is a standard feature of *ThruScan (* optional for ThruScan s3/s6)*

For further durations the Extra Battery Pack should be connected to the WTMD. See Section 7.3.

It is possible to start the WTMD from UPS. This may allow a limited time operation as per the battery charge level.

****What do the coded error messages appearing on the display mean?***

Your WTMD constantly monitors its own operations and displays the appropriate coded messages in extraordinary situations. These messages do not necessarily mean that your WTMD has a failure. They just indicate that there is an extraordinary situation related with its usage. In such cases the operating conditions of the WTMD should be checked and the technical service should be called. See section 6.4 for the coded error and warning messages in display.

****I forgot my password. What should I do?***

Call your technical service or factory After Sale Services with your Warranty Certificate.

****What should the distance be between two WTMDs operating side by side?***

There should be a distance of 30 cms at least, between two operating WTMDs. Read your manual first before operating two or more WTMDs side by side. See Section 6.13

****I want to monitor from the security observatory room the alarms of my WTMD. What should I do?***

Your WTMD has a separate relay outputs and Modem/RS232 output for PC. You may monitor the cases of alarm from a distance. For details See Section 3.6

****My WTMD generates an alarm constantly. What should I do?***

Make sure that this is not related with any adjustments made over the necessary sensitivity level in consideration of environment. Do not forget that in high sensitivity adjustments, your WTMD can detect any metals from key chains to a metal part of a shoe and all these detection may cause false alarms. Make sure that the adjusted sensitivity level is above the value measured in environment noise level.

****The traffic lights on the back of the WTMD are flashing red and green continuously. What should I do?***

There is no proper ground/earth connection on the mains line of your WTMD. Have the connection checked and normalise the ground.

**** The lights on the back of the WTMD are red all the time. What should I do?***

Make sure that the mounting of the WTMD is made correctly, that the side panels are parallel and the distance in between is 74 cms and the connector connections are made properly.

****The WTMD is not detecting under any circumstances. What should I do?***

Make sure that the connectors are plugged correctly and the ON/OFF Switch on the main card is ON position. Check whether there is any soldering failure or break off inside the connectors or wires.

****The WTMD is not giving an audio signal. What should I do?***

Make sure the sound and tone are not shut off. Check the settings unit. Check the loudspeaker inside the Control Unit. See Section 4.1.4



10. APPENDIX

10.1 CERTIFICATE OF EXPERTISE

Certificate of Expertise, certifies that the *ThruScan* taken, in random from the production line of Elektral® A.S, conforms to the general test criteria and matches the standards envisioned throughout the world.

The Magnetic Field Strength of *ThruScan*, appears much lower than have been stated by FDA. With the **VLF** technology, with its special Rx, Tx coils design and programming which minimize nil points. Thus it has an improved detection capability in comparison to its counterparts. It is further certified that it complies with the related instructions of NILECJ and FDA.

ThruScan is compatible with VDE standards for noise radiation.

Furthermore, it is certified that *ThruScan* sX-i/sX-WP comply with IP 65; *ThruScan* sX/s15-i/sX-i comply with IP 44, other models could optionally comply with IP65 when requested.

The best technological components were used for your *ThruScan* and much attention was paid for the certification of these components that were as in EU and CE directives.



10.2 SRC-SCADA REMOTE CONTROL

It is very easy to use the SRC-SCADA Remote Control Software. In this Windows based software, there is a “?” icon next to every button, to “**HELP**” the function of the button.

In Section 10.2.1 you may see the *ThruScan* s3/s6/s9 SRC SCADA Software, and in Section 10.2.2 *ThruScan* sX/sX-WP/s15-i/sX-i, SRC SCADA Software user manuals.



10.2.1 *ThruScan* s3/ s6/s9 SRC-SCADA Remote Control Program User Manual

Please enter your Registration Code for the activation of your SRC-SCADA Remote Control Programmer. You can have your Registration Code from your dealer by e-mail or telephone.

- 1.1- **Language** - Select your language from “Setting” window.(English, German, Spanish, Turkish)
- 1.2- **Connection** – To work with a metal detector you need to connect it to a serial port via the cable. To make the program, please make sure what port you are using, select the “Com Port” and choose COM1 to COM4. **If the communication is performed by Telephone Lines then the com-port of the modem should be selected visually.** You can check several ports simultaneously for the right communication.
- 1.3- If the communication would be done by telephone lines; then the phone number should be entered to “ **Phone Number**” window and pressed “**Dial**”. There is no difference between local (in house), domestic or international communications.
- 1.4- **Selection of GATE NO** - You have to give index number for each walk-throughs from 1 to 16.
(Note: All *ThruScan* s3/s6/s9 number-1 at the factory out-put)
(Note: During organising the network; When you communicate with selected *ThruScan* s3/s6/s9, you should disconnect the other Magnetic Walk-Thru Metal Detectors from your network !)
To change the *ThruScan* s3/s6/s9s index number: (Only one *ThruScan* s3/s6/s9 has to be connected to the network)

- a) Arrange the communication. (Select right COM port)
 - b) Press "**STOP**" button,
 - c) Write "**NEW**"(Caps Letters!) to "**IN COUNT**" window,
 - d) Write the index number(1-16) you want to assign to that *ThruScan* s3/s6/s9 to "**OUT COUNT**" window,
 - e) Press to "**IN COUNT**" button,
- You can repeat this process with the other Magnetic Walk-Thru Metal Detectors under communication to assign your own index number.
- 1.5- Select the Magnetic *ThruScan* 's number from "**GATE NO**" window. This will up-date the complete information on your SCADA screen at your pc for the data of the selected walk-thru.
"**STATUS**" window will display not only your executions such as, RUN(X), STOP, READ ERROR, IR(INFRARED) ERROR, LOW BATTERY etc.. i.e. the error codes (Telephone line disconnection displayed as READ ERROR) but also the walk-thru' errors are displayed.
 - 1.6- In "**Level Select**" window; 10 security levels are existing of which NC (NILECJ) can not be changed. The other 9 can be assigned to the desired sensitivity. You can also change several Security Levels simultaneously and send together to your *ThruScan* s3/s6/s9.
To change the Security Level Adjustments:
 - a) Press "**STOP**" button,
 - b) Set the Security Level you want to change its sensitivity at a value between 0-245 (0- the most sensitive , 245- the less sensitive)
 - c) "**Send**" it or them to your Magnetic Walk-Thru Metal Detector. (One or more can be send at the same time !)
 - 1.7- "?" signs for all windows are for help MENU.
 - 1.8- "**SEND**" button resets old data and memorise the new assigned data to your *ThruScan* s3/s6/s9.
 - 1.9- "**Refresh**" button reports the data of your *ThruScan* s3/s6/s9 in every 30secs to your PC. You could get data instantly every second by pressing "**Refresh**" button. "Send" is not possible in Refresh Mode.
 - 1.10- "**Factory Settings**" button enables to return to default settings. These settings can be re memorised by "**SEND**" button. Counter values do not change at this process.
 - 1.11- "**X**" button is for to quit from your SRC-SCADA Remote Control Programmer. This will shut down the communication/telephone line also.

The author reserve the rights and disclaims all warranties as to this software, whether express or implied, including without limitation any implied warranties of merchantability or fitness for a particular purpose. Use under your own responsibility, but comments (even critique) in English, German (or in Turkish) are welcome.

10.2.2 *ThruScan* sX/sX-WP/s15-i/sX-i SRC-SCADA Remote Control Program User Manual

Please enter your Registration Code for the activation of your SRC-SCADA Remote Control Programmer. You can have your Registration Code from your dealer by e-mail or telephone.

- 1.1- **Language** - Select your language from "Setting" window.(English, German, Spanish, Turkish)
- 1.2- **Connection** – To work with a metal detector you need to connect it to a serial port via the cable. To make the program, please make sure what port you are using, select the "Com Port" and choose COM1 to COM4. **If the communication is performed by Telephone Lines then the com-port of the modem should be selected visually.** You can check several ports simultaneously for the right communication.
- 1.3- If the communication would be done by telephone lines; then the phone number should be entered to "**sX Phone Number**" window and pressed "**Dial**". There is no difference between local (in house), domestic or international communications.
- 1.4- **Selection Of GATE NO** - You have to give index number for each walk-thru from 1 to 99.
(Note: All *ThruScan* s number-1 at the factory out-put)
(Note: When you communicate with selected *ThruScan* s, you should disconnect the other Magnetic Walk-Thru Metal Detectors from your network !)
To change the *ThruScan* s index number: (Only one *ThruScan* has to be connected to the network)
 - a) Arrange the communication. (Select right COM port)
 - b) Press "**STOP**" button,
 - c) Write "**NEW**"(Caps Letters!) to "**IN COUNT**" window,
 - d) Write the index number(1-99) you want to assign to that walk-thru to "**OUT COUNT**" window,
 - e) Press to "**IN COUNT**" button,
You can repeat this process with the other Magnetic Walk-Thru Metal Detectors under communication to assign your own index number.
- 1.5- Select the *ThruScan* number from "**GATE NO**" window. This will up-date the complete information on your SCADA screen at your pc for the data of the selected walk-thru.
"**STATUS**" window will display not only your executions such as, RUN(X), STOP, READ ERROR, IR(INFRARED) ERROR, LOW BATTERY etc.. i.e. the error codes (Telephone line disconnection displayed as READ ERROR) but also the walk-thru' errors are displayed.

- 1.6- In "**Level Select**" window; 20 security levels are existing of which NC (NILECJ) can not be changed. The other 19 can be assigned to the desired sensitivity. Last channel AD (AUTO DESIGNATE) is assigned for the automatic designation of the metal volume. (Pls. refer to your "Manual" for further information)
 You can change several Security Levels simultaneously and send together to your Magnetic Walk-Thru Metal Detector. Please note that; The sensitivity assignments performed at "Sensitivity Select" are for ALL ZONES !
 To change the Security Level Adjustments:
- d) Press "**STOP**" button,
 - e) Select the Security Level you want to change its sensitivity,
 - f) Set it at a value between 0-245 (0- the most sensitive , 245- the less sensitive)
 - g) "**Send**" it or them to your *ThruScan*. (One or more can be send at the same time !)
- 1.7- By "**Zone Select**" section window; all zones can be adjusted separately.
- 1.8- "?" signs for all windows are for "HELP" menu to ease you to use SRC-Scada Remote Control Program.
- 1.9- "**SEND**" button resets old data and memorize the new assigned data to your *ThruScan*.
- 1.10- "**Refresh**" button reports the data of your *ThruScan* in every 30 secs to your PC. You could get data instantly every second by pressing "**Refresh**" button. "Send" is not possible in Refresh Mode.
- 1.11- "**Factory Settings**" button enables to return to default settings. These settings can be re memorized by "**SEND**" button. Counter values do not change at this process.
- 1.12- Select "Real Time" from the "Options" at the bottom of the SCADA screen in order to observe the detection, counting, audible, visible alerts instantly.
 Select from "Options"(1 to 5) to set the alarms duration on the screen.
- 1.13- Select "Data Registration" from "Options" to register the history of incoming/outgoing and alarmed counter values at an automatically opened file.
- 1.14- "**X**" button is to exit from your SRC-SCADA Remote Control Programmer. This will shut down the communication/telephone line also.

The author reserve the rights and disclaims all warranties as to this software, whether express or implied, including without limitation any implied warranties of merchantability or fitness for a particular purpose. Use under your own responsibility, but comments (even critique) in English, German (or in Turkish) are welcome.

10.3 IRDA REMOTE CONTROL UNIT MANUEL

Pin Code Insertion:

It is necessary to insert 4 digit pin-code (****) to start procedures. Thus first 4 digit pin-code numbers should be entered from remote.

 (RUN(X)) button returns the WTMD to its operational model and exits from IRDA programming mode.



a) Used to return back to operational mode(WTMD) after adjustments performed such as Security Level, Alarm Tone Level. b) To return to sub-Menu from Remote Control Menu.



To shut off the alarm tone.



To adjust the volume of alarm tone level. (increase/decrease)



Security Level Adjustments. (increase/decrease)



Counter Visibility (on / off)



Alarm Counter Reset (make nil)



To Reset incoming/outgoing counters. (select 1 for incoming & select 2 for outgoing or select 3 for both counters)



Return to factory defaults.

- P0-
P9** Security Level Adjusts (adjusts between security level "NC" and security level "09")
- ✓ YES button (to select YES/OK in all above MENUs)
- ✗ NO button (to select NO/REJECT in all above MENUs)
- L** Language Selection; 1. English, 2. German, 3. Turkish, 4. Spanish

10.4 User's manual for Wheeled Transportation Accessory /WTMD Wheeler

Operation:

This device is designed as an accessory for the WTMD Models(all) ThruScan s3/s9/sX/sX-i/sX-WP and for transportation purposes only. To use this accessory correctly, make sure that you have assembled the apparatus properly. The assembled WTMD should be carefully placed into the transportation accessory and then the item number (h) should be used to fix the accessory by screwing to the bottom part of the side panels.(Make sure that you are not screwing extremely tight NOT TO CAUSE ANY DAMAGE ON THE PLASTIC SIDE PANELS) After getting on the WTMD on the "Wheeled Transportation Accessory", carefully lay down the WTMD then hold up the both(side panels) on wheels by firmly holding, slowly ride your WTMD to the new place you want.

Figure 1

Fixing parts for the "Wheeled Transportation Accessory" is shown on this chart below.

Figure 2

Assembled, Wheeled Transportation Accessory for WTMD (all models).

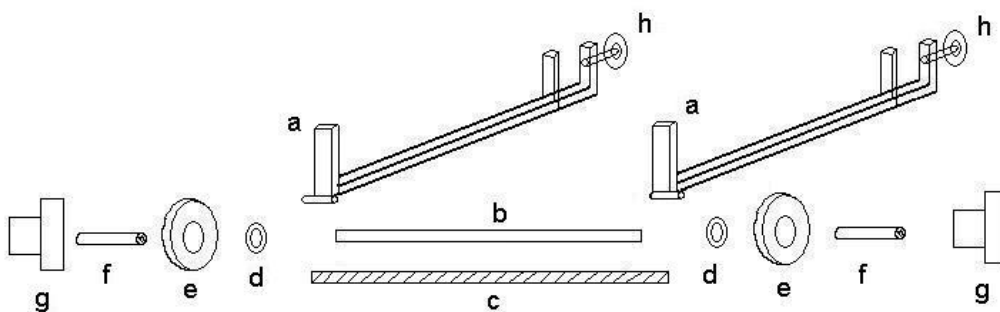

Figure 1



Figure 2

- 1- Place item number (b) between pieces shown as (a) on the figure 1
- 2- Item number (c) to be fixed through the hole.
- 3- Items numbered (d) to be fixed at both ends of the item number (c)

- 4- Place item number (f) through item number (e-the wheels) to be fixed at both ends of item number (c) as shown on the Figure 1 and Figure 2
- 5- Item number (g) should be fixed at both ends.

*To disassemble; the steps described above should be followed in reverse.

10.5 CERTIFICATE OF WARRANTY

FULL WARRANTY CERTIFICATE

Your Unit, Model:.....

Serial/Model No :.....

Which you purchased on ___/___20___ is hereby warranted against defect in workmanship and material for a period as follows: ___ YEARS

1. Within the Warranty period, ELEKTRAL® will repair or replace, without charge, any part or parts that prove to be defective. The defective instruments should be returned, accompanied by the attached SERVICE OR REPAIR CARD to ELEKTRAL® Izmir Ataturk Industrial Zone M.K. Ataturk Blv. 23 Cigli 35620 Izmir-Turkey where the overhaul is performed also.
2. Upon expiration of the Warranty, ELEKTRAL® A.S. further guarantees to repair this merchandise at a cost of the current listed ELEKTRAL® price.
3. This warranty is void if
 - the instrument has been damaged or broke down through misuse
 - instrument has been altered or tampered with in any way
 - instrument has been damaged through accident, misuse or negligence
 - the seal, ties or stickers on the instrument has been broken
 - damage or defects occur because of through lightning and fire
 - replacement or repair is necessitated be loss or damage resulting from any cause beyond the control of ELEKTRAL®
 - the instrument has been used against the instructions stated in the user's manual
 - your warranty has not been among our files by your request with "Warranty Information Card"
 - only ELEKTRAL® A.S. is authorized to confirm above mentioned particulars.
 - all price and costs are FOB Izmir-TR. All the transport or travel costs are bared by the buyer.
4. ELEKTRAL® is not to be labelled for loss of other damage allegedly resulting from defects in its products.
5. This Warranty gives you specific legal rights. Please Include Model Number and purchase date in correspondence regarding this instrument.

All Warranty Services are at our Factory. All transportation risks and costs to and pro our Factory belongs to Customer.

Thank you for selecting a product manufactured by ELEKTRAL® A.S. Before using your new item please take a minute to read and fill out the forms on the reverse side of this card.

The Warranty Information Card helps us learn more about you and what you purchase. From this information come improvements and new products for you, our valued customers. Please return this card within 10 days of purchase.

The full Warranty Certificate tells you that we stand behind our products and will repair this item as long as you own the product, per the terms of the warranty certificate.

The Service or repair card is your way of communicating with our Customer Service Department should a problem occur. It helps us to quickly service your product and return it as soon as possible. Please complete and include this card whenever you return a product again.

Thank you once again for selecting our product. We hope this will be one of the many ELEKTRAL® products you will own.

Date/Place Purchased :.....

Invoice Date, No :.....

Dealer Company's Title :.....

Address :.....

.....

Telephone-Fax :.....

E-mail :.....

DEALER COMPANY :.....



Seal/Signature